



DEAFF
INDUSTRIAL IDENTITY ITALIA

57

INDICE PRODUCTOS

-ACCESOROS ILUMINACIÓN	PAG. 127
-AFORADORES COBO	PAG. 53-55
-AFORADORES COCHE CLASICO	PAG. 56
-AIENTOS COBO	PAG. 131-132
-BASES, CLAVIJAS Y ESPIRALES REMOLQUE	PAG. 13-20
-BOCINAS	PAG. 3-6
-BOMBAS LIMPIAPARABRISAS	PAG. 7-12
-CONMUTADORES LUCES	PAG. 23-30
-DESCONECTADORES BATERIA	PAG. 64-68
-ENCENDEORES BASES Y CONECTORES	PAG. 1-2
-FAROS PRINCIPALES	PAG. 69-77
-FAROS SEGURIDAD CARRETILLAS	PAG. 126
-FAROS TRABAJO	PAG. 118-125
-ILUMINACIÓN AUXILIAR LED	PAG. 113-117
-INSTRUMENTACIÓN UNIDEK	PAG. 52
-INTERRUPTORES CLAUSOR	PAG. 37
-INTERRUPTORES COBO	PAG. 31-36
-INTERRUPTORES COBO ESPECIALES	PAG. 42-46
-INTERRUPTORES ELEVACIONES TURISMO	PAG.39-40
-INTERRUPTORES LUCES TURISMO	PAG. 38
-INTERRUPTORES WARNING TURISMO	PAG. 41-42
-KIT'S CONECTORES INSTALACIÓN	PAG. 21-22
-LLAVES DE CONTACTO	PAG. 47-51
-LUCES CONTROL	PAG. 131
-LUCES DE MATRICULA	PAG. 127-128
-MATERIAL INSTALACIÓN	PAG.62
-PILOTOS DELANTEROS	PAG. 78-82
-PILOTOS LATERALES Y GALIBO	PAG.83-86
-PILOTOS TRASEROS	PAG. 87-100
-RELES	PAG. 58
-RELES DE ARRANQUE	PAG. 57
-RELES INTERMITENCIAS	PAG. 59
-RELES TEMPORIZADORES Y ESPECIALES	PAG. 60
-ROTATIVOS Y DESTELLANTES	PAG. 101-111
-SAPRISA	PAG.63-64



14.0625

ENCENDEDOR UNIVERSAL
TENSIÓN: 12V SIN LUZ
FIJACIÓN TUERCA

14.0626

ENCENDEDOR UNIVERSAL
TENSIÓN: 24V SIN LUZ
FIJACIÓN TUERCA

14.0803

ENCENDEDOR UNIVERSAL
TENSIÓN: 12V C/LUZ LED VERDE
FIJACIÓN RAPIDA

15.0803

ENCENDEDOR ORIGINAL GRUPO VAG
TENSIÓN: 12V C/LUZ LED ROJO
FIJACIÓN RAPIDA



14.0804

ENCENDEDOR UNIVERSAL
TENSIÓN: 12V—C/ LUZ LED VERDE
FIJACIÓN RAPIDA

14.0830

ENCENDEDOR UNIVERSAL
TENSIÓN: 24V—C/ LUZ LED VERDE
FIJACIÓN RAPIDA

14.0877

TENSIÓN: > 12/24V.
BASE TOMA CORRIENTE
SIN LUZ
FIJACIÓN RÁPIDA GRAPA
TAPA TERMOPLÁSTICA
CAJA 10 UNIDADES



14.0878

TENSIÓN: > 12V
BASE TOMA CORRIENTE
CON LUZ LED VERDE
FIJACIÓN RÁPIDA GRAPA
TAPA TERMOPLÁSTICA
CAJA 10 UNIDADES

14.0880

TENSIÓN: > 12/24V.
BASE TOMA CORRIENTE
SIN LUZ
FIJACIÓN TUERCA
TAPA TERMOPLÁSTICA
CAJA 10 UNIDADES



BA-08003

TENSIÓN: > 12/24V.
BASE TOMA CORRIENTE
SUPERFICIE
FIJACIÓN TORNILLOS
TAPA TERMOPLÁSTICA
TIPO KIRSTEN ISO 4165

BA-07002

TENSIÓN: > 12/24V. ISO 4165
BASE TOMA CORRIENTE
Ø18,5 PVC / TAPA TERMOPLASTICA

25.019.100 

TENSIÓN: > 12/24V.
BASE TOMA CORRIENTE
Ø18,5 / METALICA ISO 4165



BA-01000

TENSIÓN: 12/24V.
BASE X 3 TOMA CORRIENTE
CARGA MAX. 20A
Ø 21
SUJECIÓN TORNILLOS
MONTAJE SUPERFICIE

BA-01500

TENSIÓN: 12 /24V.
BASE TOMA CORRIENTE X 3
CARGA MAX. 20A
Ø 21
SUJECIÓN TORNILLOS
CABLEADO 2 MTS
CLAVIJA ENCENDEDOR Ø 21



BA-01600

TENSIÓN: 12 /24V.
BASE TOMA CORRIENTE X 3
CARGA MAX. 20A
2 TOMAS Ø 21
2 SALIDAS USB/A 5,5 V 2,5A
CABLEADO 2 MTS
CLAVIJA ENCENDEDOR Ø 21

BA-02002

TENSIÓN: 12/24 V.
BASE TOMA CORRIENTE X 3
CARGA MAX. 20A
Ø 21
SUJECIÓN TORNILLOS
MONTAJE EMPOTRADO





AD-72900

TENSIÓN: 12/24 V.
 ADAPTADOR TIPO KIRSTEN
 (ISO 4165) A Ø 21mm ISO 4165
 CARGA MÁX 16A

CL-11010 (16 Amp)

TENSIÓN: 12/24 V.
 CLAVIJA TOMA CORRIENTE
 CARGA MÁX 16 A
 Ø 21 + Ø 11,5
 CONEXIÓN TORNILLO
 CAJA 24 UNIDADES



(8 Amp) CL-11000

TENSIÓN: 12/24 V.
 CLAVIJA TOMA CORRIENTE
 CARGA MÁX 8 A
 Ø 21 + Ø 11,5
 CONEXIÓN TORNILLO
 CAJA 24 UNIDADES

CL-1100L (8Amp)

TENSIÓN: 12/24 V.
 CLAVIJA TOMA CORRIENTE
 CON TESTIGO LED
 CARGA MÁX 8 A
 Ø 21 + Ø 11,5
 CONEXIÓN TORNILLO
 CAJA 24 UNIDADES



(8Amp) CL-1100F

TENSIÓN: 12/24 V.
 CLAVIJA TOMA CORRIENTE
 CON FUSIBLE INTERIOR
 CARGA MÁX 8 A
 Ø 21 + Ø 11,5
 CONEXIÓN TORNILLO
 CAJA 24 UNIDADES

CL-08315

TENSIÓN: 12/24 V.
 CLAVIJA TOMA CORRIENTE
 TIPO KIRSTEN ISO 4165
 CARGA MÁX 8 A
 Ø 11,5
 CONEXIÓN TORNILLO
 BOLSA 10 UNIDADES



CL-05000

TENSIÓN: 12/24 V.
 CLAVIJA TOMA CORRIENTE
 TIPO KIRSTEN ISO 4165
 CARGA MÁX 8 A
 Ø 11,5
 CONEXIÓN TORNILLO
 CAJA 24 UNIDADES

BA-21400

TENSIÓN: ENTRADA 12/ 24V.
 TENSIÓN SALIDA 5 V.
 INTENSIDAD SALIDA 65W
 UNA SALIDA USB 3.0
 UNA SALIDA USB C
 CON LUZ
 CON INTERRUPTOR ON-OFF



BA-21100

TENSIÓN: ENTRADA 12/ 24V.
 TENSIÓN SALIDA 5 V.
 INTENSIDAD SALIDA 2,5 A x 2
 DOS SALIDAS USB/A 2.0
 TAPA ESTANCA
 POLARIDAD PROTEGIDA
 PROTECCIÓN SOBRECARGA

BA-21200

TENSIÓN: ENTRADA 12/ 24V.
 TENSIÓN SALIDA 5 V.
 INTENSIDAD SALIDA 3 A
 UNA SALIDA USB/A 2.0
 POLARIDAD PROTEGIDA
 PROTECCIÓN SOBRECARGA



BA-21300

TENSIÓN: ENTRADA 12/ 24V.
 TENSIÓN SALIDA 5 V.
 INTENSIDAD SALIDA 3,6 A x 2
 UNA SALIDA USB/A 2.0
 UNA SALIDA USB/C
 POLARIDAD PROTEGIDA
 PROTECCIÓN SOBRECARGA

BA-39000

TENSIÓN: ENTRADA 12/ 24V.
 TENSIÓN SALIDA 5 V.
 INTENSIDAD SALIDA 3 A
 UNA SALIDA USB/A
 POLARIDAD PROTEGIDA
 PROTECCIÓN SOBRECARGA
 MONTAJE SUPERFICIE





K70H2M-12V

TENSIÓN: 12 V
2 TERMINALES
430 Hz TONO AGUDO
CONEXIÓN FASTON
ELECTRONAGNÉTICA
SONIDO : 108 db
Ø 70



K91H2M-6V

TENSIÓN: 6V
2 TERMINALES
430 Hz TONO AGUDO
CONEXIÓN FASTON
ELECTRONAGNÉTICA
SONIDO : 113 db
Ø 90



K91H1M-12V

TENSIÓN: 12V
1 TERMINAL
430 Hz TONO AGUDO
CONEXIÓN FASTON
ELECTRONAGNÉTICA
SONIDO : 113 db
Ø 90



K91L2M-12V

TONO GRAVE 340Hz
CONEXIÓN 2 FASTON
ELECTRONAGNÉTICA
SONIDO : 113 db

K91L2M-24V

TONO GRAVE 340Hz
CONEXIÓN 2 FASTON
ELECTRONAGNÉTICA
SONIDO : 113 db

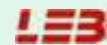

K91H2M-12V

TENSIÓN: 12V
2 TERMINALES
430 Hz TONO AGUDO
CONEXIÓN FASTON
ELECTRONAGNÉTICA
SONIDO : 113 db
Ø 90

K91H2M-24V

TENSIÓN: 24V
2 TERMINALES
430 Hz TONO AGUDO
CONEXIÓN FASTON
ELECTRONAGNÉTICA
SONIDO : 113 db
Ø 90

K91H2M36/48

TENSIÓN: 36/48 V
2 TERMINALES
TONO AGUDO
CONEXIÓN FASTON
ELECTRONAGNÉTICA
ESPECIAL CARRETILLAS
SONIDO : 113 db

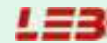

JUEGOS DE BOCINAS CON CONECTORES ORIGINALES

TENSIÓN: 12 V
BOCINAS ESPECIALES
TONO GRAVE/ AGUDO
510 Hz ± 20 + 410 Hz ± 20
ELECTRONAGNÉTICAS
SOPORTE
SONIDO : 109 db



T80-12V/OPEL

CONECTOR ESPECIAL
OPEL / GM JGO. 2 BOCINAS



T80-12V/OPEL2

CONECTOR ESPECIAL
OPEL / GM JGO. 2 BOCINAS

T80-12V/PSA

CONECTOR ESPECIAL
GRUPO PSA JGO. 2 BOCINAS



T80-12V/PSA2

CONECTOR GRUPO PSA
MODERNO JGO. 2 BOCINAS



T80-12V/VW

CONECTOR ESPECIAL
GRUPO VAG JGO. 2 BOCINAS



T80-12V/VW2

CONECTOR ESPECIAL
GRUPO VAG JGO. 2 BOCINAS

T80-12V/HYUN

CONECTOR ESPECIAL
HYUNDAI JGO. 2 BOCINAS





T80/2N-12V

2 TERMINALES
500 Hz + 410 Hz
CONEXIÓN FASTON
ELECTRONAGNÉTICA
SOPORTES+RELE
SONIDO : 112 db



T80/2N-24V

2 TERMINALES
500 Hz + 410 Hz
CONEXIÓN FASTON
ELECTRONAGNÉTICA
SOPORTES+RELE
SONIDO : 112 db



TN91/2

TENSIÓN: 12 V
ESPECIAL NAÚTICA
CROMO MARINIZADO
470 Hz + 410 Hz
ELECTRONAGNÉTICA
SOPORTES + RELE
SONIDO : 109 db



T91/2C-12V

TENSIÓN: 12V
2 TERMINALES
500 Hz + 410 Hz
CROMADAS
ELECTRONAGNÉTICA
SOPORTES+RELE
SONIDO : 109 db



PN/2P-12V

BOCINA ELECTRONEUMÁTICA
2 TROMPETAS + COMPRESOR
TONO GRAVE / AGUDO
800 Hz + 750 Hz
SOPORTE
SONIDO 115 db



PN/2P-24V

BOCINA ELECTRONEUMÁTICA
2 TROMPETAS + COMPRESOR
TONO GRAVE / AGUDO
800 Hz + 750 Hz
SOPORTE
SONIDO 115 db



PN/3P-12V

BOCINA ELECTRONEUMÁTICA
3 TROMPETAS + COMPRESOR
TONO GRAVE / AGUDO
800 Hz + 750 Hz + 600 Hz
SOPORTE
SONIDO 115 db



PN/3P-24V

BOCINA ELECTRONEUMÁTICA
3 TROMPETAS + COMPRESOR
TONO GRAVE / AGUDO
800 Hz + 750 Hz + 600 Hz
SOPORTE
SONIDO 115 db



PN1-12V

BOCINA ELECTRONEUMÁTICA
TONO GRAVE
CONEXIONADO FASTÓN
110 db - 300 Hz
SOPORTE
SONIDO 115 db



PN1-24V

BOCINA ELECTRONEUMÁTICA
TONO GRAVE
CONEXIONADO FASTÓN
110 db - 300 Hz
SOPORTE
SONIDO 115 db



PN2S-12V

BOCINA ELECTRONEUMÁTICA
CONEXIONADO FASTÓN
530 Hz + 670 Hz
SOPORTE
SONIDO 115 db



PN2S-24V

BOCINA ELECTRONEUMÁTICA
CONEXIONADO FASTÓN
530 Hz + 670 Hz
SOPORTE
SONIDO 115 db





M91/1L-12V

BOCINA NAUTICA CROMADA
TONO GRAVE 330Hz 109dB
C/ SOPORTES

M91/1L-24V

BOCINA NAUTICA CROMADA
TONO GRAVE 330Hz 109dB
C/ SOPORTES



M91/1H-12V

BOCINA NAUTICA CROMADA
TONO AGUDO 380Hz 109dB
C/ SOPORTES

M91/1H-24V

BOCINA NAUTICA CROMADA
TONO AGUDO 380Hz 109dB
C/ SOPORTES



ACTC/651

BOCINA AIRE CALDERIN
TONO BAJO 210 Hz
ACERO INOX
LARGO 573 mm
SOPORTE
AIRE COMPRIMIDO
SONIDO 116 db



ACTC/701

BOCINA AIRE CALDERIN
TONO ALTO 170Hz
ACERO INOX
LARGO 673 mm
SOPORTE
AIRE COMPRIMIDO
SONIDO 116 db



ACTC/2

JGO BOCINA AIRE CALDERIN
BITONO 425Hz+375 Hz
ACERO INOX
LARGO MAX. 379 mm
C/ SOPORTES
AIRE COMPRIMIDO
SONIDO 116 db



TR/MAX

TENSIÓN: 24 V
BOCINA AIRE CALDERIN
TONO GRAVE
ELECTROVALVULA 24 V
SOPORTE
AIRE COMPRIMIDO
SONIDO 117 db



BEL-GAS

BOCINA GAS ECOLOGICO
USO MARITIMO
SONIDO 116db



1/BGAS

RECAMBIO BOTELLA
GAS ECOLOGICO

TR/EPQ

TENSIÓN: 12 V
BOCINA SONIDO EPOCA
520 Hz
ELECTROMAGNETICA
SOPORTE
SONIDO 102 db



EV-12V

ELECTRO VALVULA
BOCINA AIRE CALDERIN
12V 3 TERMINALES

EV-24V

ELECTRO VALVULA
BOCINA AIRE CALDERIN
24V 3 TERMINALES

VP

VALVULA AIRE PEDAL

V/TIR

VALVULA AIRE TIRADOR





GK1211
 TENSIÓN: 12/24 V.
 AVISADOR ACÚSTICO
 Ø 55 mm
 SOPORTE ÁNGULO
 CONEXIÓN FASTON + KIT
SONORIDAD 86/94 db



GK9000
 TENSIÓN: 10 - 80 V.
 AVISADOR ACÚSTICO
 FIJACIÓN TORNILLO
 CONEXIÓN TORNILLO
SONORIDAD 97 db



GK0948
 TENSIÓN: 9V-48V.
 AVISADOR ACÚSTICO
 FIJACIÓN TORNILLO
 CONEXIÓN TORNILLO
SONORIDAD 110 db



GK1248
 TENSIÓN: 9-48 V.
 AVISADOR ACÚSTICO
 FIJACIÓN TORNILLO
 DOBLE NIVEL DE SONIDO
 AMBIENTES EXTREMOS
TIPO CATERPILLAR
SONORIDAD 115 db



AV.18.0040
 TENSIÓN 12 V
 AVISADOR ACÚSTICO
SONORIDAD 65 db
 RANGO FUN. 10-16 V.
 SINCRONIZACIÓN DE SONIDO 15'



31.0033.0000
 TENSIÓN 12 V
 AVISADOR ACÚSTICO
 Ø 32 mm
SONORIDAD 92 db
 RANGO FUN. 8-18 V.



31.022.000
 TENSIÓN: 9-32V.
 AVISADOR ACÚSTICO Ø 44 mm
SONORIDAD 85 +/- 5 db
 2900 Hz +/- 500
 SONIDO CONTINUO /
 DISCONTINUO



31.007.01
 TENSIÓN: 10-32 V.
 AVISADOR ACÚSTICO
SONORIDAD 95 +/- 5 db
 SOPORTE
 85x66x47



31.024.01
 TENSIÓN: 11-100 V.
 AVISADOR ACÚSTICO
SONORIDAD 95 +/- 5 db
 SOPORTE
 85x66x47



GK0402
 TENSIÓN: 6-24V.
 MINI AVISADOR ACÚSTICO
 FIJACIÓN TORNILLO
 CONEXIÓN CABLE
SONORIDAD 86 db



GK0534
 TENSIÓN: 12-24V.
 AVISADOR ACÚSTICO PUERTA
 DING-DONG TIPO BUS
SONORIDAD 80 db



AV.BE.A1310
 TENSIÓN: 10-32 V.
 AUTO AJUSTABLE
 AVISADOR ACÚSTICO
SONORIDAD 82 / 102dB
 SAE J 994
 100*77*32



BAL-01

TENSIÓN: 12 V
2 TERMINALES
2 TUBOS ENTRADA - SALIDA
CONEXIÓN FASTON
SOPORTE
UNIVERSAL



BAL-02

TENSIÓN: 24 V
2 TERMINALES
2 TUBOS ENTRADA - SALIDA
CONEXIÓN FASTON
SOPORTE
UNIVERSAL



BAL-03

TENSIÓN: 12 V
2 TERMINALES
2 TUBOS ENTRADA - SALIDA
CONEXIÓN FASTON 90°
DEPÓSITO
FORD-FIAT-PSA-HONDA



BAL-04

TENSIÓN: 12 V
2 TERMINALES
2 TUBOS ENTRADA - SALIDA
CONEXIÓN FASTON 90°
DEPÓSITO
VAG-BMW-OPEL-VOLVO



BAL-05

TENSIÓN: 12 V
2 TERMINALES
2 TUBOS ENTRADA - SALIDA
CONEXIÓN FASTON 90°
DEPÓSITO
ROVER - HONDA



BAL-06

TENSIÓN: 12 V
2 TERMINALES
2 TUBOS ENTRADA - SALIDA
CONEXIÓN FASTON 90°
DEPÓSITO
VAG-BMW-OPEL-VOLVO



BAL-07

TENSIÓN: 12 V
2 TERMINALES
2 TUBOS ENTRADA - SALIDA
CONEXIÓN FASTON 90°
DEPÓSITO
PSA



BAL-09

TENSIÓN: 12 V
2 TERMINALES
2 TUBOS ENTRADA - SALIDA
CONEXIÓN CONECTOR
DEPÓSITO
PSA - KIA-HYUNDAI- FORD



BAL-10
TENSIÓN: 12 V
2 TERMINALES
1 TUBOS ENTRADA 2 SALIDAS
CONEXIÓN CONECTOR
DEPÓSITO
FORD



BAL-11

TENSIÓN: 12 V
2 TERMINALES
2 TUBOS ENTRADA - SALIDA
CONEXIÓN CONECTOR
DEPÓSITO
ROVER-HONDA-AUSTIN



BAL-12

TENSIÓN: 12 V
2 TERMINALES
2 TUBOS ENTRADA - SALIDA
CONEXIÓN CONECTOR
DEPÓSITO
NISSAN-ROVER-CRYSLER

BAL-13

TENSIÓN: 12 V
2 TERMINALES
2 TUBOS ENTRADA - SALIDA
CONEXIÓN FASTON
SOPORTE
UNIVERSAL





BAL-14
 TENSIÓN: 24 V
 2 TERMINALES
 1 TUBO ENTRADA - 1 SALIDA
 CONEXIÓN FASTON
 SOPORTE
UNIVERSAL 24 V

BAL-15
 TENSIÓN: 12 V
 2 TERMINALES
 1 TUBO ENTRADA - 2 SALIDAS
 CONEXIÓN FASTON
 DEPOSITO - CONECTOR
SEAT-AUDI-VW-SKODA-



BAL-16
 TENSIÓN: 12 V
 2 TERMINALES
 1 TUBO ENTRADA - 1 SALIDA
 CONEXIÓN FASTON
 KIT BOLSA + ACCESORIOS
UNIVERSAL 12V 19,5 x 27,0

BAL-18
 TENSIÓN: 12 V
 2 TERMINALES
 1 TUBO ENTRADA - 1 SALIDA
 CONEXIÓN CONECTOR
 KIT BOLSA + ACCESORIOS
BMW



BAL-19
 TENSIÓN: 12 V
 2 TERMINALES
 1 TUBO ENTRADA - 2 SALIDAS
 CONEXIÓN 2 PINS
 DEPOSITO - CONECTOR
SEAT-AUDI-VW-SKODA-OPEL
1J6 955 651 = BAL-30

BAL-20
 TENSIÓN: 12 V
 2 TERMINALES
 1 TUBO ENTRADA - 1 SALIDA
 CONECTOR
 CONEXIÓN 2 PINS
PSA 6434.58



BAL-21
 TENSIÓN: 12 V
 2 TERMINALES
 1 TUBO ENTRADA - 2 SALIDAS
 CONEXIÓN 2 PINS
 CONECTOR
PSA - FIAT 6434.60

BAL-22
 TENSIÓN: 12 V
 2 TERMINALES
 1 TUBO ENTRADA - 1 SALIDA
 CONECTOR
 CONEXIÓN 2 PINS
RENAULT 7704002215



BAL-23
 TENSIÓN: 12 V
 2 TERMINALES
 1 TUBO ENTRADA - 2 SALIDAS
 CONEXIÓN 2 PINS
 DEPOSITO - CONECTOR
SEAT-AUDI-VW-SKODA-OPEL

BAL-24
 TENSIÓN: 12 V
 2 TERMINALES
 1 TUBO ENTRADA - 1 SALIDA
 CONECTOR
 CONEXIÓN 2 PINS
RENAULT



BAL-25
 TENSIÓN: 24 V
 2 TERMINALES
 1 TUBO ENTRADA - 1 SALIDA
 CONEXIÓN FASTON
 KIT BOLSA + ACCESORIOS
UNIVERSAL 24V 19,5 x 27,0

BAL-26
 TENSIÓN: 12 V
 2 TERMINALES
 1 TUBO ENTRADA - 2 SALIDA
 CONECTOR
 CONEXIÓN 2 PINS
RENAULT 7700821782





BAL-27

TENSIÓN: 12 V
 2 TERMINALES
 1 TUBO ENTRADA - 2 SALIDAS
 CONEXIÓN CONECTOR
 CONECTOR 2 PINS
RENAULT - PSA -NISSAN



BAL-28

TENSIÓN: 12 V
 2 TERMINALES
 1 TUBO ENTRADA - 1 SALIDA
 CONECTOR
 CONEXIÓN 2 PINS Ø
MERCEDES BENZ



BAL-29

TENSIÓN: 12 V
 2 TERMINALES
 1 TUBO ENTRADA - 1 SALIDA
 CONECTOR
 CONEXIÓN 2 PINS
RENAULT PSA



BAL-30

TENSIÓN: 12 V
 2 TERMINALES
 1 TUBO ENTRADA - 2 SALIDAS
 CONEXIÓN 2 PINS
 DEPOSITO - CONECTOR
SEAT-AUDI-VW-SKODA-OPEL
1J6 955 651 = BAL-19



BAL-31

TENSIÓN: 12 V
 2 TERMINALES
 1 TUBO ENTRADA - 1 SALIDA
 CONEXIÓN 2 PINS
LAVA FAROS
GRUPO VAG—OPEL



BAL-32

TENSIÓN: 12 V
 2 TERMINALES
 1 TUBO ENTRADA - 1 SALIDA
 CONEXIÓN FASTON
 KIT DEPOSITO + ACCESORIOS
UNIVERSAL 12 V
165x125x100 mm



BAL-33

TENSIÓN: 24 V
 2 TERMINALES
 1 TUBO ENTRADA - 1 SALIDA
 CONEXIÓN FASTON
 KIT DEPOSITO + ACCESORIOS
UNIVERSAL 24 V
165x125x100 mm



BAL-35

TENSIÓN: 12 V
 2 TERMINALES
 1 TUBO ENTRADA - 1 SALIDA
 CONECTOR
 CONEXIÓN 2 PINS Ø
SEAT - FIAT - JEEP



BAL-37

TENSIÓN: 12 V
 2 TERMINALES
 1 TUBO ENTRADA - 1 SALIDA
 CONECTOR
 CONEXIÓN 2 PINS
SEAT-AUDI-VW-SKODA-OPEL
1J0 955 681
 CONEXIÓN FASTON



BAL-39

TENSIÓN: 12 V
 2 TERMINALES
 1 TUBO ENTRADA - 1 SALIDA
 CONECTOR
 CONEXIÓN 2 PINS
CITROEN BERLINGO - SAXO



BAL-40

TENSIÓN: 12 V
 2 TERMINALES
 1 TUBO ENTRADA - 1 SALIDA
 CONECTOR
 CONEXIÓN 2 PINS Ø
SEAT - FIAT - JEEP



BAL-41

TENSIÓN: 12 V
 2 TERMINALES
 1 TUBO ENTRADA - 1 SALIDA
 CONECTOR FASTON
 CONEXIÓN 2 PINS



24 VOLS **BAL-42**

TENSIÓN: 24 V
2 TERMINALES
1 TUBOS ENTRADA - 1 SALIDA
CONEXIÓN FASTON 90°
ENTRADA DEPÓSITO

MERCEDES-SCANIA-VOLVO



BAL-43 **24 VOLS**

TENSIÓN: 24 V
2 TERMINALES
1 TUBOS ENTRADA - 1 SALIDA
CONEXIÓN FASTON
SOPORTE L



MERCEDES-SCANIA-VOLVO-UNI.



BAL-44

TENSIÓN: 12 V
2 TERMINALES
1 TUBOS ENTRADA - 1 SALIDA
CONEXIÓN CONECTOR
ENTRADA DEPÓSITO

GRUPO VAG
4A0955651 - 1J0 955 681

BAL-45

TENSIÓN: 12 V
2 TERMINALES
1 TUBOS ENTRADA - 1 SALIDA
CONEXIÓN CONECTOR
ENTRADA DEPÓSITO

MITSUBISHI



BAL-46

TENSIÓN: 24 V
2 TERMINALES
1 TUBOS ENTRADA - 1 SALIDA
CONEXIÓN FASTON

UNIVERSAL
24 VOLS



BAL-47

TENSIÓN: 24 V
2 TERMINALES
1 TUBOS ENTRADA - 2 SALIDAS
CONECTOR
ENTRADA DEPÓSITO

RENAULT RVI
24 VOLS



BAL-49

TENSIÓN: 12 V
2 TERMINALES
1 TUBOS ENTRADA - 1 SALIDAS
CONECTOR
ENTRADA DEPÓSITO

VOLVO DELANTERA



BAL-50

TENSIÓN: 12 V
2 TERMINALES
1 TUBOS ENTRADA - 1 SALIDAS
CONECTOR
ENTRADA DEPÓSITO

VOLVO TRASERA



BAL-52

TENSIÓN: 12 V
2 TERMINALES
1 TUBOS ENTRADA - 1 SALIDA
CONEXIÓN CONECTOR
ENTRADA DEPÓSITO

VOLSWAGEN 1H5 955 651



BAL-53

TENSIÓN: 12 V
2 TERMINALES
1 TUBOS ENTRADA - 1 SALIDA
CONEXIÓN CONECTOR
ENTRADA DEPÓSITO

VOLVO



BAL-55

TENSIÓN: 12 V
1 TUBOS ENTRADA - 1 SALIDA
CONEXIÓN FASTON
ENTRADA DEPÓSITO

FORD- GRUPO PSA- RENAULT



BAL-56

TENSIÓN: 12 V
2 TERMINALES
1TUBOS ENTRADA - 1 SALIDA
CONEXIÓN CONECTOR
ENTRADA DEPÓSITO

RENAULT



BAL-57

TENSIÓN: 12 V
3 TERMINALES
1 ENTRADA - 2 SALIDAS
CONEXIÓN CONECTOR
ENTRADA DEPOSITO
AUDI 4A0 955 651 A/B

BAL-58

TENSIÓN: 12 V
2 TERMINALES
1 ENTRADA - 1 SALIDA
CONEXIÓN CONECTOR
ENTRADA DEPOSITO
FORD - KIA - HYUNDAI



BAL-66

TENSIÓN: 12 V
2 TERMINALES
1 ENTRADA - 1 SALIDA
CONEXIÓN CONECTOR
ENTRADA DEPOSITO
TOYOTA - MAZDA

BAL-67

TENSIÓN: 12 V
2 TERMINALES
1 ENTRADA - 2 SALIDA
CONEXIÓN CONECTOR
ENTRADA DEPOSITO
**KIA-HYUNDAI-CHEVROLET
MITSUBISHI - MAZDA**



BAL-68

TENSIÓN: 12 V
2 TERMINALES
1 ENTRADA - 1 SALIDA
CONEXIÓN CONECTOR
ENTRADA DEPOSITO
**KIA-HYUNDAI-CHEVROLET
MITSUBISHI - MAZDA**

BAL-69

TENSIÓN: 12 V
2 TERMINALES
1 ENTRADA - 2 SALIDAS
CONEXIÓN CONECTOR
ENTRADA DEPOSITO
FORD



BAL-70

TENSIÓN: 12 V
2 TERMINALES
1 ENTRADA - 2 SALIDAS
CONEXIÓN CONECTOR
ENTRADA DEPOSITO
FORD

BAL-71

TENSIÓN: 12 V
2 TERMINALES
1 ENTRADA - 1 SALIDA
CONEXIÓN CONECTOR
ENTRADA DEPOSITO
CHEVROLET



BAL-72

TENSIÓN: 12 V
2 TERMINALES
1 ENTRADA - 1 SALIDA
CONEXIÓN CONECTOR
ENTRADA DEPOSITO
CHEVROLET

BAL-73

TENSIÓN: 12 V
2 TERMINALES
1 ENTRADA - 2 SALIDA
CONEXIÓN CONECTOR
ENTRADA DEPOSITO
CHEVROLET



BAL-74

TENSIÓN: 12 V
2 TERMINALES
1 ENTRADA - 1 SALIDA
CONEXIÓN CONECTOR
ENTRADA DEPOSITO
CHEVROLET

BAL-76

TENSIÓN: 12 V
2 TERMINALES
2 TUBOS 1 ENTRADA - 1 SALIDA
CONEXIÓN CONECTOR
ENTRADA DEPOSITO
HONDA - TOYOTA- L. ROVER





BAL-77
 TENSIÓN: 12 V
 2 TERMINALES
 1 ENTRADA - 1 SALIDA
 CONEXIÓN CONECTOR
 ENTRADA DEPOSITO
KIA - HYUNDAI



BAL-79
 TENSIÓN: 12 V
 2 TERMINALES
 1 ENTRADA - 1 SALIDA
 CONEXIÓN CONECTOR
 ENTRADA DEPOSITO
NISSAN



BAL-82
 TENSIÓN: 12 V
 2 TERMINALES
 1 ENTRADA - 2 SALIDAS
 CONEXIÓN CONECTOR
 ENTRADA DEPOSITO
NISSAN



BAL-83
 TENSIÓN: 12 V
 2 TERMINALES
 1 ENTRADA - 1 SALIDA
 CONEXIÓN CONECTOR
 ENTRADA DEPOSITO
TOYOTA



BAL-89
 TENSIÓN: 12 V
 2 TERMINALES
 1 ENTRADA - 1 SALIDA
 CONEXIÓN CONECTOR
 ENTRADA DEPOSITO
UNIVERSAL LAVAFAROS



BAL-92
 TENSIÓN: 12 V
 2 TERMINALES
 1 ENTRADA - 2 SALIDAS
 CONEXIÓN CONECTOR
 ENTRADA DEPOSITO
SEAT-AUDI-VW-SKODA
1K6 955 651 - 8K9 955 651



BAL-93
 TENSIÓN: 12 V
 2 TERMINALES
 2 TUBOS 1 ENTRADA - 1 SALIDA
 CONEXIÓN CONECTOR
 ENTRADA DEPOSITO
CITROEN - FIAT - PSA



BAL-600
 2 TUBOS 1 ENTRADA - 1 SALIDA
 FIJACIÓN TORNILLOS
 BOMBA MANUAL
SEAT - 600
UNIVERSAL



BAL-JG
 JUNTA DE ESTANQUEIDAD
 Ø 6/8



IB-100
 MOTOR BLOCA PUERTAS
 TENSIÓN 12 V
VALEO 256414
RENAULT 7701029259 - 7701036565 -
7701038652
UNIVERSAL



BAL-JP
 JUNTA DE ESTANQUEIDAD
 10-12mm





BA-0201

TENSIÓN: 12V.
POLOS : 7
NORMA: ISO 1724
MATERIAL: ALUMINIO
CONEXIÓN: TORNILLOS
BASE HEMBRA

BA-201F

TENSIÓN: 12V.
POLOS : 7
NORMA: ISO 1724
MATERIAL: ALUMINIO
CONEXIÓN: FASTON 6.3mm
BASE HEMBRA



CL-0101

TENSIÓN: 12V.
POLOS : 7
NORMA: ISO 1724
MATERIAL: ALUMINIO
CONEXIÓN: TORNILLOS
CLAVIJA MACHO

CL-0102

TENSIÓN: 12V.
POLOS : 7
NORMA: ISO 1724
MATERIAL: PVC
CONEXIÓN: TORNILLO
CLAVIJA MACHO



BA-0202

TENSIÓN: 12V.
POLOS : 7
NORMA: ISO 1724
MATERIAL: PVC
CONEXIÓN: TORNILLOS
BASE HEMBRA

BA-202/N

TENSIÓN: 12V.
POLOS : 7
NORMA: ISO 1724
MATERIAL: PVC
CONEXIÓN: TORNILLO
BASE HEMBRA
C/ DESCONEXIÓN ANTINIEBLA



BA-0203

TENSIÓN: 24V.
POLOS : 7—TIPO "N"
NORMA: ISO 1185
MATERIAL: ALUMINIO
CONEXIÓN: TORNILLOS
BASE HEMBRA
TERMINALES 7 MACHOS

BA-0204

TENSIÓN: 24V.
POLOS : 7—TIPO "S"
NORMA: ISO 3731
MATERIAL: ALUMINIO
CONEXIÓN: TORNILLOS
BASE HEMBRA
TERM. 6 MACHOS/1HEMBRA



BA-203F

TENSIÓN: 24V.
POLOS : 7—TIPO "N"
NORMA: ISO 1185
MATERIAL: ALUMINIO
CONEXIÓN: FASTON 6.3mm
BASE HEMBRA
TERMINALES 7 MACHOS

BA-204F

TENSIÓN: 24V.
POLOS : 7—TIPO "S"
NORMA: ISO 3731
MATERIAL: ALUMINIO
CONEXIÓN: FASTON 6.3mm
BASE HEMBRA
TERM. 6 MACHOS/1HEMBRA



CL-0103

TENSIÓN: 24V.
POLOS : 7—TIPO "N"
NORMA: ISO 1185
MATERIAL: ALUMINIO
CONEXIÓN: TORNILLO
*CL-0099 PVC / TORNILLO
*CL-103F METALICA / FASTON

CL-0104

TENSIÓN: 24V.
POLOS : 7—TIPO "S"
NORMA: ISO 3731
MATERIAL: ALUMINIO
CONEXIÓN: TORNILLO
*CL-0100 PVC / TORNILLO
*CL-104F METALICA / FASTON 6.3





*** BA-206/T BA-0206**
 TENSIÓN: 24 V.
 POLOS : 15
 NORMA: ISO 12098 DIN72570
 MATERIAL: PVC
 CONEXIÓN: PRESIÓN
 BASE HEMBRA
 * BA/206/T CONEXIÓN TORNILLO



CL-0106 *CL-106/T
 TENSIÓN: 24 V.
 POLOS : 15
 NORMA: ISO 12098 DIN 72570
 MATERIAL: PVC
 CONEXIÓN: PRESIÓN
 CLAVIJA MACHO
 CL-106/T CONEXIÓN TORNILLO



BA-0208
 TENSIÓN: 24 V.
 POLOS : 13
 NORMA: ISO 12098 DIN72570
 MATERIAL: PVC
 CONEXIÓN: PRESIÓN
 BASE HEMBRA



CL-0108
 TENSIÓN: 24 V.
 POLOS : 13
 NORMA: ISO 12098 DIN 72570
 MATERIAL: PVC
 CONEXIÓN: PRESIÓN
 CLAVIJA MACHO



*** BA-209/T BA-0209**
 TENSIÓN: 24 V.
 POLOS : 7
 NORMA: ISO 7638-1
 MATERIAL: PVC
 CONEXIÓN: PRESIÓN
ABS-EBS BASE HEMBRA
 * BA/209T CONEXIÓN TORNILLO



CL-0109 *CL-109/T
 TENSIÓN: 24 V.
 POLOS : 7
 NORMA: ISO 12098 DIN 72570
 MATERIAL: PVC
 CONEXIÓN: PRESIÓN
 CLAVIJA MACHO **ABS-EBS**
 CL-109/T CONEXIÓN TORNILLO



BA-0207
 TENSIÓN: 12V.
 POLOS : 13
 NORMA: ISO 11446
 MATERIAL: PVC
 CONEXIÓN: TORNILLOS
 BASE HEMBRA CON JUNTA



BA-207/N
 TENSIÓN: 12V.
 POLOS : 13
 NORMA: ISO 11446
 MATERIAL: PVC
 CONEXIÓN: TORNILLOS
 BASE HEMBRA CON JUNTA
CON DESCONEXIÓN LUZ NIEBLA



CL-0107
 TENSIÓN: 12V.
 POLOS : 13
 NORMA: ISO 11446
 MATERIAL: PVC
 CONEXIÓN: TORNILLOS
 CLAVIJA HEMBRA CON



AD-0202
 TENSIÓN: 12V.
 BASE AEREA 7 POLOS
 PVC ISO 1724



BA-1199
 TENSIÓN: 12V.
 BASE AEREA 13 POLOS
 PVC ISO 11446
 CONEXIÓN TORNILLOS



BA-0201-13
 FORMATO FRANCIA
 TENSIÓN: 12V
 BASE 13 POLOS
 DIN 1724 - NEN 6120
 7 POLOS + 6 POLOS
 PVC
CONTACTOS 7 + 6



CL-0101-13
 FORMATO FRANCIA
 TENSIÓN: 12V
 CLAVIJA 13 POLOS
 DIN 1724 - NEN 6120
 7 POLOS + 6 POLOS
 PVC
CONTACTOS 7 + 6



COBO → **25.036.100**

TENSIÓN: 12/24V. 20A
POLOS : 3
NORMA: DIN 9680
MATERIAL: PVC
BASE HEMBRA
CONEXIÓN FASTON 6,3

DERIT → **BA-6817**

25.036.200 ← **COBO**

TENSIÓN: 12/24V. 20A
POLOS : 3
NORMA: DIN 9680
MATERIAL: PVC
BASE MACHO
CONEXIÓN FASTON 6,3

CL-6818 ← **DERIT**



COBO → **25.038.100**

TENSIÓN: 12/24V. 20A
POLOS : 3
NORMA: DIN 9680
MATERIAL: PVC
FIJACIÓN 4 TORNI- BASE HEMBRA
CONEXIÓN FASTON 6,3

DERIT → **BA-6847**

25.033.100 * **COBO**

25.034.100 ** **COBO**

25.033.200 **COBO**

TENSIÓN: 12/24V 25A
POLOS : 2 / 3
NORMA: DIN 9680

* BASE 2 POLOS MACHOS

**BASE TRES POLOS MACHOS

CLAVIJA TRES POLOS HEMBRA



COBO → **25.001.100**

TENSIÓN: 12/24V. 20A
POLOS : 2
NORMA: DIN 9680
MATERIAL: PVC
BASE HEMBRA
CONEXIÓN FASTON 6,3

DERIT → **BA-6819**

25.001.200 ← **COBO**

TENSIÓN: 12/24V. 20A
POLOS : 2
NORMA: DIN 9680
MATERIAL: PVC
BASE MACHO
CONEXIÓN FASTON 6,3

CL-6820 ← **DERIT**



COBO **25.0058.0100**

TENSIÓN: 12V.30A
POLOS : 3
NORMA: ISO 17612
MATERIAL: PVC
BASE HEMBRA
CONEXIÓN FASTON 6,3

25.0058.0200 **COBO**

TENSIÓN: 12V.30A
POLOS : 3
NORMA: ISO 17612
MATERIAL: PVC
CLAVIJA MACHO
CONEXIÓN FASTON 6,3



BA-0402

TENSIÓN: 12/24 V 16A
POLOS : 3
NORMA: ISO 1724
MATERIAL: PVC
BASE HEMBRA
CONEXIÓN TORNILLO

CL-0401

TENSIÓN: 12/24 V. 16A
POLOS : 3
NORMA: ISO 1724
MATERIAL: PVC
CLAVIJA MACHO
CONEXIÓN TORNILLO



BA-0404

TENSIÓN: 12/24 V 16A
POLOS : 4
NORMA: ISO 72575
MATERIAL: PVC
BASE HEMBRA
CONEXIÓN TORNILLO

CL-0403

TENSIÓN: 12/24 V. 16A
POLOS : 4
NORMA: ISO 72575
MATERIAL: PVC
CLAVIJA MACHO
CONEXIÓN TORNILLO





BA-0197
 BASE BIPOLAR (2P) NATO
 NORMA: NATO 5935
 MATERIAL: ALUMINIO TRATADO
 BASE HEMBRA
 CONTACTOS LATON PLATA
 AISLANTE GOMA
BA-0197/ECO SIN HOMOLO. NATO

PG-02.35RM

CLAVIJA BIPOLAR (2P) NATO
 NORMA: NATO 5935
 MATERIAL: ACERO TRATADO
 CLAVIJA MACHO ROSCADA
 CONTACTOS LATON PLATA
 EMPUÑADURA DE GOMA



PG-02.35RM/ECO SIN HOMOLO. NATO



CL-0198
 CLAVIJA BIPOLAR NATO
 NORMA: NATO 5935
 MATERIAL: ACERO TRATADO
 CLAVIJA MACHO
 CONTACTOS LATON PLATA
 EMPUÑADURA DE GOMA

CL-1203

CLAVIJA 12 POLOS NATO
 NORMA: NATO 5935
 MATERIAL: GOMA
 CONTACTOS LATON PLATA
 AISLANTE GOMA



BA-0222
 TAPA BASE 12 POLOS
 BA-0221
 COLOR VERDE NATO

BA-0221

BASE 12 POLOS NATO
 NORMA: NATO 5935
 MATERIAL: METAL ANTIRROTURAS
 BASE HEMBRA
 CONTACTOS LATON PLATA
 AISLANTE PVC



BA-3002
 BASE BIPOLAR NATO
 NORMA: NATO 5935
 MATERIAL: PVC COMPACTO
 BASE HEMBRA
 CONTACTOS LATON PLATA
 AISLANTE GOMA

BA-1630

BASE BIPOLAR NATO
 NORMA: NATO 5935
 MATERIAL: METAL BREAK PROOF
 BASE HEMBRA
 CONTACTOS LATON PLATA
 AISLANTE GOMA



PU-2x35-29/0 → 3,3 mts
PU-2x35-40/0 → 4,0 mts
PU-2x35-60/0 → 6,0 mts
 ESPIRAL TIPO NATO DOBLE
 2xØ35 mm2
 LONGITUD TRABAJO 3,30 MTS
 4 MTS
 6 MTS
BIPOLAR ROJO / NEGRO

PU-2x35-CCR

ESPIRAL TIPO NATO
 2 x Ø 35 mm2
 LONGITUD TRABAJO 4 MTS
 BIPOLAR ROJO NEGRO
CON CLAVIJAS PG-02.35RM



PU-2x35-CCC

SIN HOMOLOGACION NATO



CL-1289
 TENSIÓN: 24 V / 500A (1000A MAX)
 POLOS : 2
 STANAG 4074 / MIL-PRF-62122
 MATERIAL: METAL ANTIRROTURAS
 CLAVIJA NATO
 CABLE :70mm2

BA-1321

TENSIÓN: 24 V / 500A (1000A MAX)
 POLOS : 2
 STANAG 4074 / MIL-PRF-62122
 MATERIAL: METAL ANTIRROTURAS
 BASE NATO
 CABLE: 70mm2
 C/ TAPA





AD-5546/C

ADAPTADOR 13P-7P
CALVIJA 13 POLOS
BASE 7 POLOS
PVC
CONTACTOS 13 - 7
VERSIÓN CORTO



AD-5546

ADAPTADOR 13P-7P
CALVIJA 13 POLOS
BASE 7 POLOS
PVC
CONTACTOS 13 - 7
VERSIÓN STANDAR



AD-5546/L

ADAPTADOR 13P-7P
CALVIJA 13 POLOS
BASE 7 POLOS
PVC
CONTACTOS 13 - 7
VERSIÓN LARGO

AD-5549C

ADAPTADOR 7P-13P
CALVIJA 7 POLOS
BASE 13 POLOS
PVC
CONTACTOS 7-13
VERSIÓN CORTO



AD-5547

AD-5547/15

ADAPTADOR 9 / 12 PINS
CALVIJA 15 POLOS A
BASE 7 TIPO "N"
BASE 7 TIPO "S"
PVC CONTACTOS 9

AD-0199

ADAPTADOR NATO
PARA CLAVIAS CL-0198 Y CL-0197



AD-5557/15 → 5 Mts

AD-5557/15L → 7.5 Mts

AD-5557/15C → 3,50 Mts

AD-5557 → 4,50 Mts**

AD-5557/15ECO → 4 Mts

ADAPTADOR 12 PINS
CALVIJA 15 POLOS A
CLAVIJA 7 TIPO "N"
CLAVIJA 7 TIPO "S"
ALUMINIO
POLIURETANO
(9 pins ACTIVOS)**



EN-5504

ADAPTADOR / ALARGADOR
CALVIJA 7 POLOS A BASE 7
POLOS
12V PVC
LARGO CABLE 3,5 MTS
POLIURETANO

EE-5540

EE-5540-EJ → 

CABLE ESPIRAL CONEXIÓN
CLAVIJAS 7 POLOS
PVC
LARGO CABLE 3,5 MTS
POLIURETANO



EN-5502 → 3,80 Mts*

EN-5554 → 7.50 Mts

ESPIRAL CON CONECTORES
7 POLOS TIPO "N"
CLAVIJAS ALUMINIO
POLIURETANO / *MUELLE REFUERZO
Ø ESPIRAL 40 mm
CABLE 7x1,5

ES-5503 → 3,80 Mts*

ES-5555 → 7,50 Mts

ESPIRAL CON CONECTORES
7 POLOS TIPO "S"
CLAVIJAS ALUMINIO
*MUELLE REFUERZO / POLIURETANO
Ø ESPIRAL 40 mm
CABLE 7x1,5





EN-5524-EJ
 ESPIRAL CON CONECTORES
 7 POLOS TIPO "N"
 CLAVIJAS ALUMINIO
 Ø ESPIRAL 36 mm
 4,5 MTS CABLE EXTENDIDO
POLIURETANO - 6x1 +1x2,5

ES-5525-EJ
 ESPIRAL CON CONECTORES
 7 POLOS TIPO "S"
 CLAVIJAS ALUMINIO
 Ø ESPIRAL 36 mm
 4,5 MTS CABLE EXTENDIDO
POLIURETANO - 6x1 +1x2,5



EA-5560
 ESPIRAL CON CONECTORES
 5 POLOS - CLAVIJAS PVC
 Ø ESPIRAL 60 mm - 4,5 MTS
 2x4+5x1,5
 ISO 4141
ABS

EB-PA20*
EB-PA20/ECO (POLIURETANO)
 ESPIRAL CON CONECTORES
 7 POLOS - CLAVIJAS PVC
 Ø ESPIRAL 60 mm - 4,5 MTS
 2x4+5x1,5 / ISO 4141
ABS / EBS

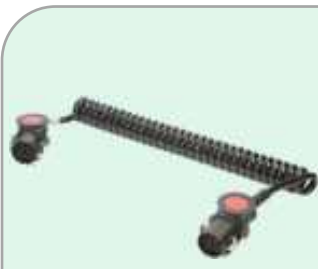

EQ-5590**
EQ-5590/ECO*
 ESPIRAL ADR CON CONECTORES
 15 POLOS
 Ø ESPIRAL 60 mm
 2x1+10x1,5+3x2,5
 *POLIURETANO
 ** POLIAMIDA

EI-5982
 ESPIRAL CON CONECTORES
 7 POLOS - RECARGA
 CLAVIJAS POLIURETANO
 Ø ESPIRAL 40 mm
POLIURETANO - 4x6+3x1
 CONECTORES ISO



EE-5510 →3,5Mts
EE-5520 →4,5Mts
EE-5530 → 4,5Mts**
 ESPIRAL SIN CONECTORES
 SECC 6x1 + 1x2,5 (7 POLOS)
 Ø ESPIRAL 60mm **POLIAMIDA**
 ** EE-5530 7X1,5mm

PU-5530
 ESPIRAL SIN CONECTORES
 SECC 7x1,5
 7 POLOS
 PU-5530 - 4,5 MTS
POLIURETANO
 Ø 40 mm



EE-1535
 ESPIRAL 3 POLOS
 SECC 3X 6mm
 3.5MTS MAX
 3P 24V/24AMP

71-CM
 MANGUERA 7 POLOS
 ROLLO 100 Mts
 7X1mm²
 GOMA



RE-0025
 MANGUERA EBS 7 POLOS
 ROLLO 25 Mts.
 5x 1.5mm² + 2x 4.0mm²

RQ-0025
 MANGUERA 15 POLOS
 ROLLO 25 Mts
 12x 1.5mm² + 3x 2.5mm²





25.0090.0000

BASE ISOBUS MASTER
ISO 11783-2
TENSIÓN: 8/32 V
MATERIAL: PVC - IP67
BASE HEMBRA
CONEXIÓN CONECTOR
XE0806193



25.0091.0000

BASE ISOBUS ESCLAVA
ISO 11783-2
TENSIÓN: 8/32 V
MATERIAL: PVC - IP67
BASE HEMBRA
CONEXIÓN CONECTOR
XE0806193



27.1020.0000

TENSIÓN: 8/32 V
ISO 11783-2
CONECTOR BASE
MATERIAL: PVC - IP67
CON TERMINALES



AV.25.0009

TENSIÓN: 8/32 V
CLAVIJA ISOBUS
ISO 11783-2
MATERIAL: PVC - IP67
CLAVIJA MACHO



BA-5959

TENSIÓN: 24 V
POLOS : 7
NORMA: ISO 25981-2
MATERIAL: POLIURETANO
BASE HEMBRA
CONEXIÓN NIQUEL PLATA
RECARGA



CL-5880

TENSIÓN: 24V
POLOS : 7
NORMA: ISO 25981-2
MATERIAL: POLIURETANO
CLAVIJA MACHO
CONEXIÓN NIQUEL PLATA
RECARGA



BA-1132

TENSIÓN: 6V-42V 30A
POLOS : 2
NORMA: DIN 14690
METAL ANTIRROTURAS
BASE ROSCADA C/ JUNTA
CABLE 6mm2 A 10mm2



CL-1070

TENSIÓN: 6V-42V 30A
POLOS : 2
NORMA: DIN 14690
METAL ANTIRROTURAS
CALVIJA ROSCADA
CABLE 6mm2 A 10mm2



AVFF.01802

CONECTOR BAYONETA
5 PINS
CON CABLE 1MTS
CONECTOR AMARILLO
PARA PILOTAJE POSTERIOR



24.0249.11

CAJA CONEX. REMOLQUE 12-32V
ISO 4009;2000 226mm X 133,5mm
-BASE 7P. TIPO "S" ISO 3731:2003
-BASE 15P. ISO 12098;2004
-BASE 7P. TIPO "N" 1185:2003
-BASE 2P. 4165;2001
27.0860.0000 (CONECTOR TRASERO 4P.)
27.0856.0000 (CONECTOR TRASERO 7P.)



AVFF.01803

CONECTOR BAYONETA
5 PINS
CON CABLE 1MTS
CONECTOR VERDE
PARA PILOTAJE POSTERIOR





CH-0381
 CONECTOR HIBRIDO CB50 48x35mm
 VOLT. 600V / 50A
 TERMINALES CABLE 16mm²

CH-0530
 CONECTOR HIBRIDO CB50 48x35mm
 VOLT. 600V / 50A
 TERMINALES CABLE 6mm²



CH-0382
 CONECTOR HIBRIDO CB50 48x35mm
 VOLT. 600V / 50A
 TERMINALES CABLE 16mm²

CH-0531
 CONECTOR HIBRIDO CB50 48x35mm
 VOLT. 600V / 50A
 TERMINALES CABLE 6mm²



CH-0383
 CONECTOR HIBRIDO CB50 48x35mm
 VOLT. 600V / 50A
 TERMINALES CABLE 16mm²

CH-0532
 CONECTOR HIBRIDO CB50 48x35mm
 VOLT. 600V / 50A
 TERMINALES CABLE 6mm²



CH-0384
 CONECTOR HIBRIDO CB175 80x55mm
 VOLT. 600V / 175A
 TERMINALES CABLE 50mm²

CH-0533
 CONECTOR HIBRIDO CB175 80x55mm
 VOLT. 600V / 175A
 TERMINALES CABLE 35mm²



CH-0385
 CONECTOR HIBRIDO CB175
 80x55mm
 VOLT. 600V / 175A

CH-0534
 CONECTOR HIBRIDO 175 80x55mm
 VOLT. 600V / 175A
 TERMINALES CABLE 35mm²



CH-0537
 CONECT. HIBRIDO CBX175 92x70mm
 VOLT. 600V / 175A
 TERMINALES CABLE 50mm²

CH-0538
 CONECT. HIBRIDO CBX175 92x70mm
 VOLT. 600V / 175A
 TERMINALES CABLE 50mm²



CH-0386
 CONECTOR HIBRIDO CB350 108x70mm
 VOLT. 600V / 350A
 TERMINALES CABLE 70mm²

CH-0387
 CONECTOR HIBRIDO CB350 108x70mm
 VOLT. 600V / 350A
 TERMINALES CABLE 70mm²



CH-0551
 CONECT. HIBRIDO CBX350 127x85mm
 VOLT. 600V / 350A
 TERMINALES CABLE 70mm²

CH-0552
 CONECT. HIBRIDO CBX350 127x85mm
 VOLT. 600V / 350A
 TERMINALES CABLE 70mm²



CH-0548
 ASA PARA CONECTORES CB50

CH-0549
 ASA PARA CONEC. CBX175 / CBX350

CH-0550
 ASA PARA CONEC. CB175 / CB350



CH-1516
 TAPON ESTANQUEIDAD CB50

CH-1517
 TAPON ESTANQUEIDAD CB175



BA-1305
 TENSIÓN: 24/48 V
 POLOS : 2
 NORMA: SW5
 MATERIAL: PVC
 BASE HEMBRA
 CONEXIÓN PRESIÓN
 CONTACTOS CU



CL-1309
 TENSIÓN: 24/48 V
 POLOS : 2
 NORMA: SW4
 MATERIAL: PVC
 CLAVIJA MACHO
 CONEXIÓN PRESIÓN
 CONTACTOS CU



27.0909.0000

KIT CONECTOR DT MACHO 2 VIAS
(TERMINALES HEMBRA)
CABLE ; 0,75mm2—1,5mm2



27.0909.5000

KIT CONECTOR DT HEMBRA 2 VIAS
(TERMINALES MACHO)
CABLE ; 0,75mm2—1,5mm2

27.0908.0000

KIT CONECTOR DT MACHO 3 VIAS
(TERMINALES HEMBRA)
CABLE ; 0,75mm2—1,5mm2



27.0908.5000

KIT CONECTOR DT HEMBRA 3 VIAS
(TERMINALES MACHO)
CABLE ; 0,75mm2—1,5mm2



27.0907.0000

KIT CONECTOR DT MACHO 4 VIAS
(TERMINALES HEMBRA)
CABLE ; 0,75mm2—1,5mm2



27.0907.5000

KIT CONECTOR DT HEMBRA 4 VIAS
(TERMINALES MACHO)
CABLE ; 0,75mm2—1,5mm2

27.0862.0000

KIT CONECTOR DT MACHO 6 VIAS
(TERMINALES HEMBRA)
CABLE ; 0,75mm2—1,5mm2



27.0862.5000

KIT CONECTOR DT HEMBRA 6 VIAS
(TERMINALES MACHO)
CABLE ; 0,75mm2—1,5mm2



27.DT08.0000

KIT CONECTOR DT MACHO 8 VIAS
(TERMINALES HEMBRA)
CABLE ; 0,75mm2—1,5mm2

27.DT08.5000

KIT CONECTOR DT HEMBRA 8 VIAS
(TERMINALES MACHO)
CABLE ; 0,75mm2—1,5mm2

27.0910.0000

KIT CONECTOR DT MACHO 12 VIAS
(TERMINALES HEMBRA)
CABLE ; 0,75mm2—1,5mm2



27.0910.5000

KIT CONECTOR DT HEMBRA 12 VIAS
(TERMINALES MACHO)
CABLE ; 0,75mm2—1,5mm2



27.0958.0000

KIT CONECTOR SEAL MACHO 2 VIAS
(TERMINALES HEMBRA)
CABLE ; 0,75mm2—1,5mm2



27.0958.5000

KIT CONECTOR SEAL HEMBRA 2 VIAS
(TERMINALES MACHO)
CABLE ; 0,75mm2—1,5mm2

27.0905.0000

KIT CONECTOR DT MACHO 3 VIAS
(TERMINALES HEMBRA)
CABLE ; 0,75mm2—1,5mm2



27.0905.5000

KIT CONECTOR DT HEMBRA 3 VIAS
(TERMINALES MACHO)
CABLE ; 0,75mm2—1,5mm2



27.0906.0000

KIT CONECTOR SEAL MACHO 4 VIAS
(TERMINALES HEMBRA)
CABLE ; 0,75mm2—1,5mm2



27.0906.5000

KIT CONECTOR SEAL HEMBRA 4 VIAS
(TERMINALES MACHO)
CABLE ; 0,75mm2—1,5mm2

27.0959.0000

KIT CONECTOR DT MACHO 5 VIAS
(TERMINALES HEMBRA)
CABLE ; 0,75mm2—1,5mm2



27.0959.5000

KIT CONECTOR DT HEMBRA 5 VIAS
(TERMINALES MACHO)
CABLE ; 0,75mm2—1,5mm2



27.0957.0000

KIT CONECTOR SEAL MACHO 6 VIAS
(TERMINALES HEMBRA)
CABLE ; 0,75mm2—1,5mm2



27.0957.5000

KIT CONECTOR SEAL HEMBRA 6 VIAS
(TERMINALES MACHO)
CABLE ; 0,75mm2—1,5mm2

27.0860.0000

KIT CONECTOR DIN 4 VIAS
(TERMINALES HEMBRA)
CABLE ; 1,5 mm2—2,5 mm2



27.0856.0000

KIT CONECTOR DIN 7 VIAS
(TERMINALES HEMBRA)
CABLE ; 1,5mm2—2,5mm2





27.0911.0000

KIT CONECTOR IVECO MACHO 3 VIAS
(TERMINALES HEMBRA) PILOTOS
CABLE ; 0,75mm2—1,5mm2

27.0864.0000

KIT CONECTOR IVECO MACHO 10 VIAS
(TERMINALES HEMBRA) PILOTOS
CABLE ; 0,75mm2—1,5mm2

27.0958.0000

CONJUNTO
KIT CONECTOR IVECO
27.0910.0000—3 VIAS
27.0864.0000 — 10 VIAS
(TERMINALES HEMBRA)



27.0936.0000

KIT CONECTOR PACKARD
MACHO 3 VIAS
(TERMINALES HEMBRA)
CABLE ; 0,75mm2—1,5mm2

27.0915.0000

CONJUNTO
KIT CONECTOR LAMPARA H9
TIPO DELPHI 2 VIAS
(TERMINALES HEMBRA)
CABLE ; 0,75mm2—1,5mm2



27.0857.0000

CONJUNTO
KIT CONECTOR LAMPARA H8/H11
GE886
TIPO DELPHI 2VIAS
(TERMINALES HEMBRA)
CABLE ; 0,75mm2—1,5mm2

27.0945.0000

CONJUNTO
KIT CONECTOR LAMPARA HB3
TIPO DELPHI 2 VIAS
(TERMINALES HEMBRA)
CABLE ; 0,75mm2—1,5mm2
**SIN CABLES



27.0904.0000

CONJUNTO
KIT CONECTOR INTERRUPTORES
COBO SERIES 700 / 900 / 1000
1100 / 1200 10 VIAS
(TERMINALES HEMBRA)
CABLE ; 0,75mm2—1,5mm2

16.650.003

CONECTOR 12 VIAS
PARA INTERRUPTOR COBO
600/1400/1500



16.600.021

CONECTOR 8 VIAS
PARA INTERRUPTOR COBO 600/1400
TERMINAL FASTON 6,4



30.16.04092

CONECTOR 4 VIAS
PARA INTERRUPTORES COBO 350/450
TERMINAL FASTON 6,4

30.16.04095

CONECTOR 8 VIAS
PARA INTERRUPTORES COBO 350/450
TERMINAL FASTON 6,4

27.1660.0000

CONJUNTO
KIT CONECTOR FAROS COBO
05.1660.0000
05.1661.0000
(TERMINALES HEMBRA)
CABLE ; 0,75mm2—1,5mm2
5 TERMINALES INCLUIDOS



27.KIH1.0000

KIT CONECTOR LAMPARA H1

SET-H7

KIT CONECTOR LAMPARA H7
CON TERMINALES

SET-H4

CONJUNTO
KIT CONECTOR LAMPARA H4
+ TERMINALES





ML-600

CONMUTADOR
INTERMITENTES
RAFAGAS - LUCES - BOCINA
SEAT 600 D / E / L
CLB2-5
11 PINS PALANCAS METAL



ML-02/32

CONM. LIMPIA INTERMITENTES
RAFAGAS - LUCES - BOCINA
LIMPIA TRASERO
FORD FIESTA - KA
1072957
21 PINS

ML-02/33

CONMUTADOR INTERMITENTES
CAMBIO DE LUCES
OPEL - CORSA - ASTRA -
VECTRA
9181010
9 PINS



ML-02/63

CONMUTADOR INTERMITENTES
CAMBIO DE LUCES
VW - SEAT
6N0 953 603
13 PINS

ML-02/64

CONMUTADOR INTERMITENTES
LUCES
VW - SEAT - SK - FORD
8L0 953 513 G
11 PINS



ML-03/21

CONMUTADOR INTERMITENTES
LUCES
FORD FIESTA MONDEO
1116710 - 1138088
10 PINS

ML-03/57

CONMUTADOR INTERMITENTES
LUCES
FORD
1062193 - 1064340
10 PINS



ML-03/96

CONM. LIMPIA INTERMITENTES
RAFAGAS - LUCES - BOCINA
MERCEDES VITO SPRINTER
0005407445
22 PINS

ML-03/97

CONM. LIMPIA INTERMITENTES
RAFAGAS - LUCES - BOCINA
MERCEDES VITO SPRINTER
0005404745
22 PINS CON LIMPIA TRASERO



ML-10/81

CONM. LIMPIA LAVA
OPEL CORSA - VECTRA - ASTRA
ZAFIRA
90243395
9 PINS

ML-21/81

CONMUTADOR LUCES BOCINA
INTERMITENTES
RENAULT TWINGO
7701046629
10 PINS





ML-23/48
 CONMUTADOR MULTIFUNCION
 AUTOBIANCHI - LANCIZ
 7560221
 19 PINS

CLE2-6
 CONMUTADOR MULTIFUNCION
 AUSTIN 1100-1300+ - MINI
 MINI VAN
 FEMSA - CLE-2-6



ML-24/92
 CONMUTADOR MULTIFUNCIÓN
 FIAT CINQUECENTO
 181739980
 5+4+4 PINS

ML-30/04
 CONMUTADOR MULTIFUNCION
 FORD ESCORT
 1027166
 21 PINS



ML-30/49
 CONMUTADOR MULTIFUNCION
 FORD FIESTA - KA - PUMA
 1072957
 21 PINS

ML-53/00
 CONMUTADOR INTERMITENTES
 LUCES - WARNING
 VOLSWAGEN - SEAT
 1H0 953 513 C
 13 PINS



ML-53/01
 CONMUTADOR LIMPIA
 RAFAGAS
 VOLSWAGEN GOLF 92-98
 1H0 953 519 C1
 8 PINS

ML-53/02
 CONMUTADOR LIMPIA
 RAFAGAS
 ORDENADOR
 VOLSWAGEN GOLF 92-98
 1H0 953 519 A
 12 PINS



ML-80/01
 CONMUTADOR LIMPIA
 RAFAGAS
 ORDENADOR
 VOLSWAGEN POLO LUPO
 6N0 953 519 B
 10 PINS

ML-80/02
 CONMUTADOR LUCES BOCINA
 INTERMITENTES
 AROSA - LUPO - POLO
 6N0 953 513
 13 PINS = ML-02/63



ML-80/09
 CONMUTADOR MULTIFUNCIÓN
 SEAT IBIZA CORDOBA POLO
 6Q0 953 513 D
 20 PINS

ML-80/11
 CONMUTADOR MULTIFUNCIÓN
 LIMPIA
 FORD ESCORT ORION
 86AU17K478BA



F N R

COBO **01.0665.0000**

CONMUTADOR INVERSOR MARCHAS
CNH - DEUTZ - SAME - 82034516

F N R

COBO **01.0705.0600**

CONMUTADOR INVERSOR MARCHAS - Ø 45 mm
CLARK - 3681729 CONEXIÓN CONECTOR DT 6 VIAS

F N R

COBO **01.0708.0600**

CONMUTADOR INVERSOR MARCHAS Y VELOCIDAD - Ø 45 mm
SITREX 634084

F N R SWITCH

COBO **01.0721.0600**

CONMUTADOR INVERSOR MARCHAS Y VELOCIDAD
- Ø 45 mm

F N R

COBO **01.0732.0000**

CONMUTADOR INVERSOR
MARCHAS Y LIMPIAPARABRISAS - Ø 45 mm

F N R

COBO **01.0734.0000**

CONMUTADOR INVERSOR MARCHAS Y VELOCIDAD - Ø 45 mm

F N R    I  II



COBO **01.0735.0600**

CONMUTADOR INVERSOR MARCHAS - VELOCIDAD- BOCINA
- Ø 38mm

F N R    I  II SWITCH



COBO **01.0738.0600**

CONMUTADOR INVERSOR MARCHAS Y VELOCIDAD
- Ø 45 mm



COBO **01.199.000**

CONMUTADOR LUCES—BOCINA—INTERMITENTES
VARIOS

F R 



COBO **01.207.000**









CONMUTADOR INVERSOR MARCHAS - Ø 38 mm
VARIOS MODELOS—SERIE 180 COBO

                      



COBO **01.221.550**

CONMUTADOR LUCES BOCINA INTERMITENTES
RECAMBIO MANDO 01.221.000 - Ø 38mm

       



COBO **01.227.000**

CONMUTADOR LUCES BOCINA INTERMITENTES
DEUTZ / SAME ESP-8004

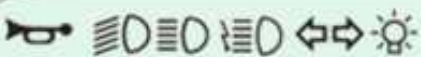

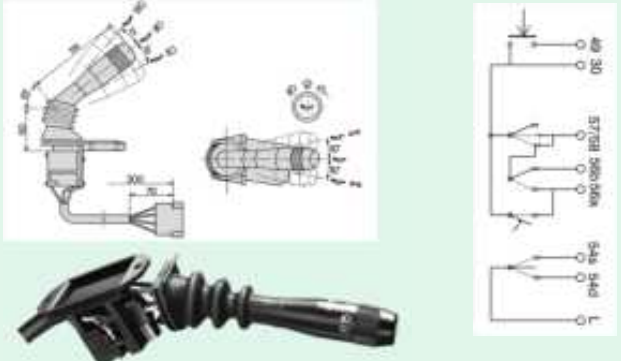

01.251.000

CONMUTADOR LUCES BOCINA INTERMITENTE
DEUTZ / SAME 0.008.7408.3/10





01.281.000

CONMUTADOR INVERSOR MARCHAS BOCINAS INTERMITENTE- Ø 38mm CARRETILLAS B-000511





01.293.000

CONMUTADOR INVERSOR MARCHAS Y VELOCIDAD - Ø 45 mm
SITREX 634084





01.309.500

CONMUTADOR LUCES BOCINA Y AGUA LIMPIAPARABRISAS





01.318.000

CONMUTADOR LUCES BOCINAS INTERMITENTES
NEW HOLLAND DEUTZ SAME 82000509





01.334.000

CONMUTADOR INVERSOR MARCHAS Y VELOCIDAD VARIOS

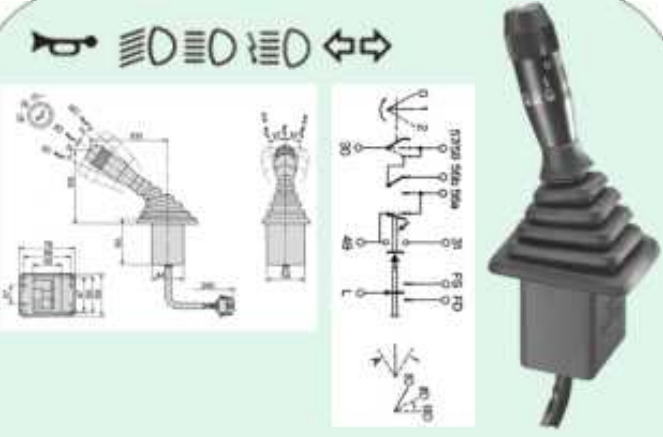

COBO **01.357.000**

CONMUTADOR LUCES - BOCINA - INTERMITENTES - 1007424
 DEUTZ - SAME - 5.1260.0020 - NEW HOLLAND - 5089705



01.365.000 **COBO**

CONMUTADOR INVERSOR MARCHAS
 VARIOS MODELOS

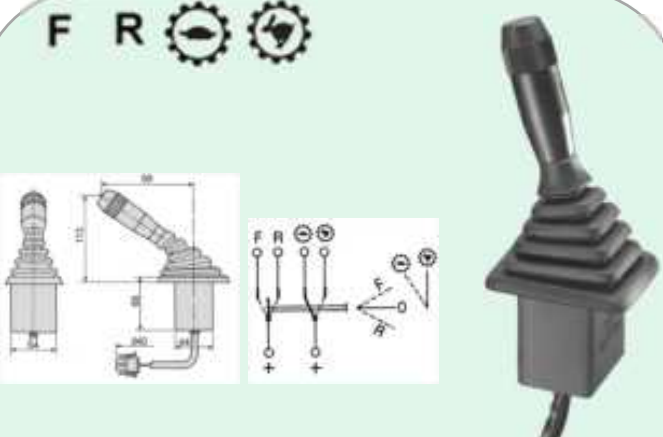

COBO **01.367.000**

CONMUTADOR INVERSOR MARCHAS
 RAPIDA / LENTA



01.368.000 **COBO**

CONMUTADOR LUCES BOCINA INTERMITENTES
 VARIOS



COBO **01.399.000**

CONMUTADOR LUCES BOCINA INTERMITENTES
 Ø 38mm



01.404.000 **COBO**

CONMUTADOR LUCES BOCINA INTERMITENTES
 VARIOS

COBO **01.412.000**
 CONMUTADOR LUCES BOCINA INTERMITENTE
 FIAT 5174200

01.455.000 **COBO**
 CONMUTADOR LUCES BOCINAS AGUA LIMPIA
 INTERMITENTE- Ø 40mm CONECTOR DT 12 VIAS

COBO **01.511.500**
 CONMUTADOR LUCES INTERMITENTES BOCINA - Ø 38 mm
 VARIOS 003157

01.504.500 **COBO**
 CONMUTADOR LUCES—LIMPIAPARABRISAS-
 INTERMITENTES Ø 45mm

COBO **01.534.000**
 CONMUTADOR LUCES BOCINAS INTERMITENTES

01.553.000 **COBO**
 CONMUTADOR INVERSOR MARCHAS
 VARIOS

CONMUTADORES VOLANTE



12201289
 TENSIÓN: 12V / 24V.
 POSICIONES : 0-1-2-3
 COONEXIÓN TORNILLO
 TUERCA Ø 22,5 mm
 CAMBIO DE LUCES
 TIPO BOSCH
 LLAVE EXTRAIBLE



23.119.000
 TENSIÓN 12V / 24V
 POSICIONES : 0-1
 TUERCA Ø 22,5 mm
 CAMBIO DE LUCES
 Ø CUERPO 44,2 mm
 TERMINALES FASTON (3)



SAME 23.100.000
 TENSIÓN 12V / 24V
 POSICIONES : 0-1-2-3
 TUERCA Ø 22,5 mm
 CAMBIO DE LUCES
 Ø CUERPO 40 mm
 TERMINALES FASTON
 LLAVE EXTRAIBLE



23.101.11
 TENSIÓN 12V / 24V
 POSICIONES : 0-1-2-3
 TUERCA Ø 22,5 mm
 CAMBIO DE LUCES + BOCINA
 Ø CUERPO 40 mm
 TERMINALES FASTON X5



SAME-FIAT 23.104.11
 TENSIÓN 12V / 24V
 POSICIONES : 0-1-2-3
 TUERCA Ø 22,5 mm
 CAMBIO DE LUCES + BOCINA
 Ø CUERPO 40 mm
 TERMINALES FASTON X6



23.107.000
 TENSIÓN 12V / 24V
 POSICIONES : 0-1-2-3
 TUERCA Ø 22,5 mm
 CAMBIO DE LUCES + BOCINA
 Ø CUERPO 40 mm
 TERMINALES FASTON X5



23.108.11
 TENSIÓN 12V / 24V
 POSICIONES : 0-1-2-3
 TUERCA Ø 22,5 mm
 CAMBIO DE LUCES + BOCINA
 Ø CUERPO 40 mm
 TERMINALES FASTON X6



23.109.11 LAMBORGHINI
 TENSIÓN 12V / 24V
 POSICIONES : P-0-1-2-3
 TUERCA Ø 22,5 mm
 CAMBIO DE LUCES + BOCINA
 Ø CUERPO 46 mm
 TERMINALES FASTON



LAMBORGHINI 23.110.11
SAME TENSIÓN 12V / 24V
 POSICIONES : 0-1-2-3
 TUERCA Ø 22,5 mm
 CAMBIO DE LUCES + BOCINA
 Ø CUERPO 40 mm
 TERMINALES FASTON X5



23.111.11
 TENSIÓN 12V / 24V
 POSICIONES : 0-1-2-3
 TUERCA Ø 22,5 mm
 CAMBIO DE LUCES + BOCINA
 Ø CUERPO 46 mm
 TERMINALES FASTON



FIAT-IVECO 23.137.000
 TENSIÓN 12/24 V
 CONMUTADOR LUCES ROTANTE
 MARCO
 CONECTOR 8 PINS
 0 - 1 - 2



23.141.000 FIAT-IVECO
 TENSIÓN 12/24 V
 CONMUTADOR LUCES ROTANTE
 CONECTOR
 0 - 1 - 2



SERIE 350-450

TECLAS INTERRUPTORES



	13.350.001		13.350.030		13.350.065		13.350.094
	13.350.002		13.350.034		13.350.074		13.350.118
	13.350.003		13.350.036		13.350.075		13.350.127
	13.350.004		13.350.056		13.350.079		13.350.131
	13.350.007		13.350.058		13.350.081		13.350.131
	13.350.022		13.350.058		13.350.081		13.350.143
	13.350.028		13.350.060		13.350.092		13.350.188
			13.350.063		13.350.093		13.350.189



SERIE 600

TECLAS INTERRUPTORES



	16.601.009		16.601.A03		16.602.009		16.602.083
	16.601.013		16.601.A09		16.602.013		16.602.097
	16.601.015		16.601.A15		16.602.015		16.602.098
	16.601.017		16.601.A86		16.602.073		16.602.A18
	16.601.069		16.601.A92		16.602.077		16.602.A47
	16.601.080		16.601.A97		16.602.081		16.602.A48
	16.601.081		16.601.B39		16.602.082		16.602.A62

SERIE 1400

TECLAS INTERRUPTORES



SERIE 700-900

TECLAS INTERRUPTORES

	16.1400.A057		16.1400.B050		16.0702.B022		16.0702.B053
	16.1400.B001		16.1400.B123		16.0702.B023		16.0702.B054
	16.1400.B010		16.1400.B187		16.0702.B024		16.0702.B065
	16.1400.B012		16.1400.C008		16.0702.B025		16.0702.B106
	16.1400.B047		16.1400.C020		16.0702.B033		16.0702.B181
	16.1400.B048		16.1900.A035		16.0702.B037		16.0702.B206
	16.1400.B049		16.1900.A045		16.0702.B042		16.0702.B615



SERIE 700

CONECTOR
30.16.06870

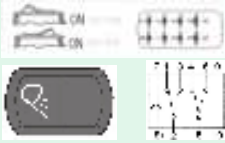
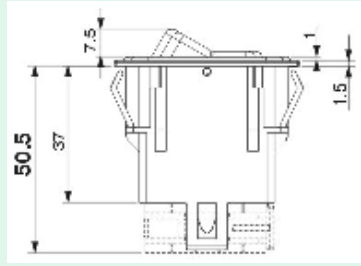

16.0701.1002.13
INTERRUPTOR FAROS AUX.
SERIE 700 C/ LUZ 12V

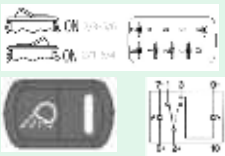

16.0717.1002.13
INTERRUPTOR LUCES AUX.
SERIE 700 C/ LUZ DOBLE 12V

16.0705.1001.14
INTERRUPTOR CARGA
SERIE 700 C/ LUZ DOBLE 24V

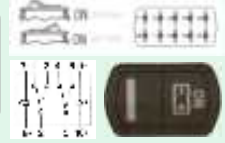

16.0722.1001.13
INTERRUPTOR WARNING
SERIE 700 C/ LUZ 12V

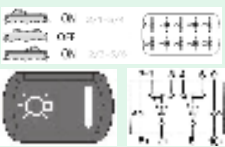
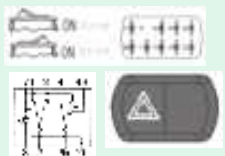

16.0748.1000.13
CONMUTADOR LUCES INT.
SERIE 700 C/ LUZ DOBLE 12V

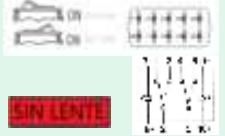

16.705.101.13
INTERRUPTOR
SERIE 700 C/ LUZ DOBLE 12V

16.701.103.14
INTERRUPTOR
SERIE 700 C/ LUZ 24V

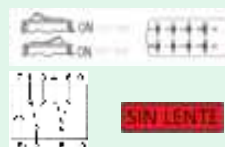

16.715.101.13
INTERRUPTOR
C/ LUZ DOBLE 12V SERIE 700

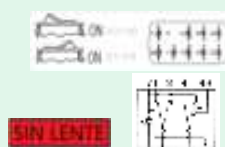

16.721.101.14
INTERRUPTOR WARNING
SERIE 700 C/ LUZ 24V



16.751.102.13
CONMUTADOR + PULSADOR
SERIE 700 C/ LUZ 12V

16.748.103.13 (12V)
16.748.103.14 (24V)
CONMUTADOR LUCES INT.
SERIE 700 C/ LUZ DOBLE

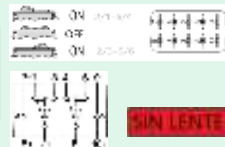

17.701.101.13
PULSADOR
C/ LUZ 12V SERIE 700

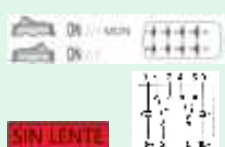
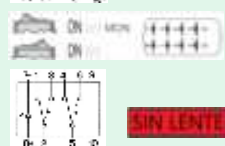

17.705.101.14
PULSADOR
SERIE 700 C/ LUZ DOBLE 24V



17.731.105.14
PULSADOR
SERIE 700 C/ LUZ 24V

16.725.103.13 (12V)
16.725.103.14 (24V)
PULSADOR CONMUTADOR
SERIE 700 C/ LUZ DOBLE

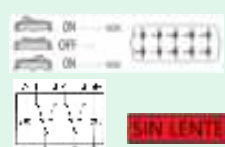

17.769.103.13
PULSADOR CONMUTADOR
C/ LUZ 12V SERIE 700

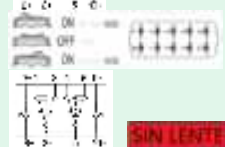

INTERRUPTORES COBO SERIES 700

700



900



1100



1200





SERIE 600-1400

SIN BOMBILLA INCORPORADA
T5W 12V / 24V

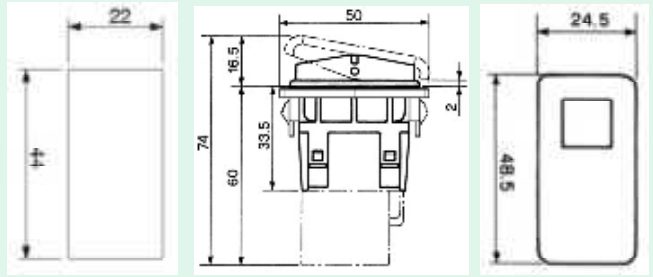

13.609.109
INTERRUPTOR FAROS AUX.
SERIE 600 C/ LUZ DOBLE

16.0677.0109
INTERRUPTOR WARNING
SERIE 600 C/ LUZ



16.603.100
INTERRUPTOR CONMUTADOR
SERIE 600-1400

16.604.100
INTERRUPTOR C/ LUZ DOBLE
SERIE 600-1400

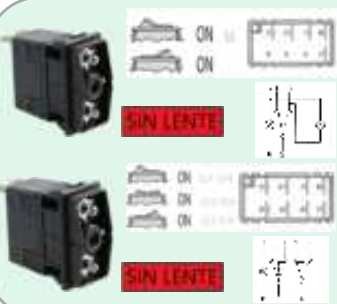

13.609.100
INTERRUPTOR .
SERIE 600-1400 C/ LUZ DOBLE

16.613.100
CONMUTADOR
SERIE 600-1400 C/ LUZ DOBLE



16.628.100
INTERRUPTOR CONMUTADOR
SERIE 600-1400

16.629.109
CONMUTADOR LUCES
C/ LUZ DOBLE SERIE 600-1400



13.633.100
CONMUTADOR
SERIE 600-1400 C/ LUZ

16.643.100
CONMUTADOR + PULSA
SERIE 600-1400 C/ LUZ DOBLE



16.653.100
CONMUTADOR
SERIE 600-1400 C/ LUZ

17.603.100
PULSADOR CONMUTADOR
C/ LUZ SERIE 600-1400

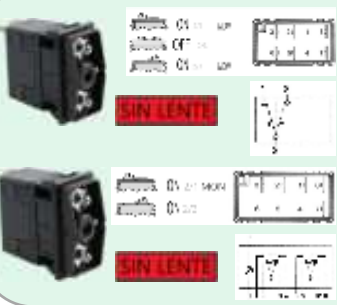

17.605.100
PULSADOR
SERIE 600-1400 S/ LUZ

16.608.100
PULSADOR
SERIE 600-1400 C/ LUZ



17.629.100
PULSADOR
SERIE 600-1400 C/ LUZ

17.603.100
PULSADOR CONMUTADOR
C/ LUZ SERIE 600-1400



30.32.04829
REMATE LATERAL
30.32.04830
REMATE CENTRAL
ACOPLAMIENTO PARA SERIES
600-1400

16.600.020
ACOPLAMIENTO PARA SERIES
350-450-600-700-900-1400

16.600.039
ACOPLAMIENTO PARA SERIES
350-450-600-1400

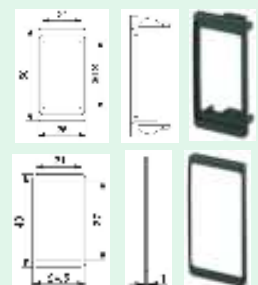

















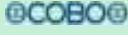























































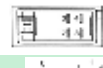
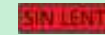

























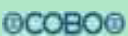



















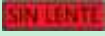

SERIE 350-450

22mm*44mm





 	  	 <p style="color: red;">13.350.000</p> <p>INTERRUPTOR SINLENTE SERIE 350-450 SIN LUZ</p>	 <p style="color: red;">13.379.000</p> <p>INTERRUPTOR LUCES INTER. SERIE 350-450</p>	  	 
 	  	 <p style="color: red;">13.369.000</p> <p>INTERRUPTOR ROTATIVO SERIE 350-450</p>	 <p style="color: red;">13.380.000</p> <p>INTERRUPTOR FAROS AUX. SERIE 350-450</p>	  	 
 	  	 <p style="color: red;">13.385.000</p> <p>INTERRUPTOR ROTATIVO SERIE 350-450</p>	 <p style="color: red;">13.395.000</p> <p>INTERRUPTOR LUCES SERIE 350-450</p>	  	 
 	  	 <p style="color: red;">16.384.000.13</p> <p>INTERRUPTOR WARNING SERIE 350-450 LANDINI/MASSEY</p>	 <p style="color: red;">16.350.000</p> <p>INTERRUPTOR C/LUZ SERIE 350-450</p>	  	 
 	  	 <p style="color: red;">16.351.000</p> <p>CONMUTADOR C/LUZ SERIE 350-450</p>	 <p style="color: red;">16.352.000</p> <p>CONMUTADOR C/ LUZ SERIE 350-450</p>	  	 
 	  	 <p style="color: red;">16.353.000</p> <p>INTERRUPTOR CONMUTADOR C/ LUZ SERIE 350-450</p>	 <p style="color: red;">16.354.000</p> <p>INTERRUPTOR CONMUTADOR SERIE 350-450 C/LUZ</p>	  	 
 	  	 <p style="color: red;">16.355.000</p> <p>CONMUTADOR C/LUZ SERIE 350-450</p>	 <p style="color: red;">16.357.000</p> <p>CONMUTADOR + PULSADOR SERIE 350-450 C/LUZ</p>	  	 
 	  	 <p style="color: red;">16.358.000</p> <p>CONMUTADOR + PULSADOR C/ LUZ SERIE 350-450</p>	 <p style="color: red;">17.351.000</p> <p>PULSADOR CONMUTADOR SERIE 350-450 C/LUZ</p>	  	 
 	  	 <p style="color: red;">17.354.000</p> <p>PULSADOR C/ LUZ SERIE 350-450</p>	 <p style="color: red;">17.355.000</p> <p>CONMUTADOR PULSADOR SERIE 350-450 C/LUZ</p>	  	 
 	  	 <p style="color: red;">17.358.000</p> <p>PULSADOR C/LUZ SERIE 350-450</p>	 <p style="color: red;">17.391.000</p> <p>PULSADOR BOCINA SERIE 350-450 C/LUZ</p>	  	 

SERIE 100/300

COBO

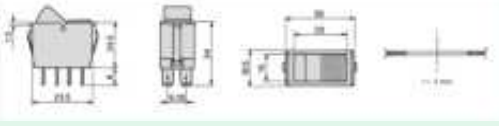
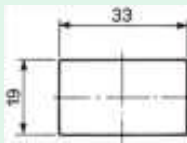

13.101.000 COBO

INTERRUPTOR LIMPIA
SERIE 100

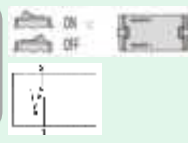

13.103.000 COBO

INTERRUPTOR LUCES CUADRO
SERIE 100

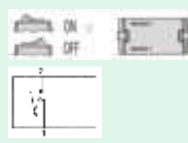

COBO 13.105.000

INTERRUPTOR LUCES
SERIE 100



COBO 13.123.000

INTERRUPTOR ROTATIVO
SERIE 100



13.124.000 COBO

INTERRUPTOR LUCES
SERIE 100

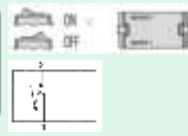

13.209.000 COBO

INTERRUPTOR WARNING
SERIE 100



COBO 13.258.000

INTERRUPTOR LUCES
SERIE 300 C/LUZ



COBO 13.123.000

INTERRUPTOR ROTATIVO
SERIE 300 C/LUZ



COBO 16.170.000

CONMUTADOR VENTILADOR
SERIE 100



COBO 16.105.000

CONMUTADOR VENTILADOR
SERIE 100



SERIE 179

COBO

INTERRUPTOR BAJO GOMA
IP44

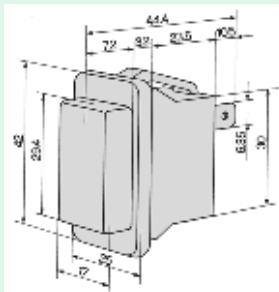

16.162.000 COBO

INTERRUPTOR LUCES
SERIE 179 6 TERMINALES

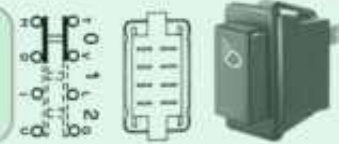

16.168.000 COBO

INTERRUPTOR LUCES
SERIE 179 6 TERMINALES



COBO 15.122.000

INTERRUPTOR CON TAPA
CONEX TORNILLO
ESTANQUEIDAD IP67
OFF-ON



15.127.000 COBO

INTERRUPTOR CON TAPA
CONEX FASTON
ESTANQUEIDAD IP67
OFF-ON

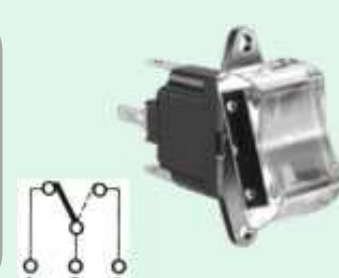

COBO

INTERRUPTOR 16.1901.1102

PLACA 16.1900.A35

INTERRUPTOR DE SEGURIDAD
TECLA CON BLOQUE
SERIE 1900





23.136.000
 TENSIÓN 12V
 INTERRUPTOR PTO
 PULSANTE IP64
 CONTACTOS LATON PLATA
 CONECTOR 4 VIAS SEAL AMP



23.148.000
 TENSIÓN 12V
 INTERRUPTOR PTO
 PULSANTE IP64
 CONTACTOS LATON PLATA
 CONECTOR 4 VIAS



23.0155.0500
 TENSIÓN 12V
 INTERRUPTOR PTO
 PULSANTE IP64
 CONTACTOS LATON PLATA
 CONECTOR 3 VIAS AMP "T"
 DESCONEXIÓN



17.0303.0000
 TENSIÓN 12 V
 POSICIONES : OFF - (ON)
 TUERCA Ø 30,5 mm
 PULSADOR TOMA FUERZA
 Ø CUERPO 40 x38 mm
 CONECTOR 3 PINS



17.0329.0000
 TENSIÓN 12 V
 POSICIONES : ON - OFF
 TUERCA Ø 30,5 mm
 INTERRUPTOR
 Ø CUERPO 40x38 mm
 TERMINALES FASTON (X6)



17.0331.0000
 TENSIÓN 12 V
 POSICIONES : OFF - (ON)
 TUERCA Ø 30,5 mm
 PULSADOR
 Ø CUERPO 40 x 38 mm
 TERMINALES FASTON (X4)



17.0332.0000
 TENSIÓN 12 V
 POSICIONES : ON - OFF
 TUERCA Ø 30,5 mm
 INTERRUPTOR TRACCIÓN
 Ø CUERPO 40x38 mm
 TERMINALES FASTON (X6)



17.0333.0000
 TENSIÓN 12 V
 POSICIONES : ON - OFF
 TUERCA Ø 30,5 mm
 INTERRUPTOR WARNING
 Ø CUERPO 40 x38 mm
 TERMINALES FASTON (X6)



17.0339.0000
 TENSIÓN 12 V
 POSICIONES : ON - OFF
 TUERCA Ø 30,5 mm
 INTERRUPTOR NEUTRO
 Ø CUERPO 40x38 mm
 TERMINALES FASTON (x6)



17.0341.0000
 TENSIÓN 12 V
 POSICIONES : ON - OFF
 TUERCA Ø 30,5 mm
 INTERRUPTOR FAROS AUX
 Ø CUERPO 40x38 mm
 TERMINALES FASTON (x6)



17.0345.0000
 TENSIÓN 12 V
 POSICIONES : ON - OFF
 TUERCA Ø 30,5 mm
 INTERRUPTOR NEUTRO
 Ø CUERPO 40x38 mm
 TERMINALES FASTON (6)



17.0352.0000
 TENSIÓN 12 V
 POSICIONES : ON - OFF
 TUERCA Ø 30,5 mm
 INTERRUPTOR WARNING
 Ø CUERPO 40 x38 mm
 TERMINALES FASTON (7)



IE-002
 INTERRUPTOR CLAUSOR
 GRUPO VAG
 4B0 905 849

IE-003
 INTERRUPTOR CLAUSOR
 G.M.—OPEL
 90052497



IE-004
 INTERRUPTOR CLAUSOR
 G.M.— OPEL
 0914852 / 90389377

IE-006
 INTERRUPTOR CLAUSOR
 GRUPO VAG
 4A0 905 849 B



IE-318
 INTERRUPTOR CLAUSOR
 GRUPO VAG
 1K0 905 865 A

IE-458
 INTERRUPTOR CLAUSOR
 FORD
 1062207



IE-553
 INTERRUPTOR CLAUSOR
 GRUPO VAG
 111 905 865 L

IE-563
 INTERRUPTOR CLAUSOR
 GRUPO VAG
 6N0 905 865



IE-2242
 INTERRUPTOR CLAUSOR
 G.M.—OPEL
 9115863

IE-2243
 INTERRUPTOR CLAUSOR
 G.M.—OPEL
 90589314



IE-2244
 INTERRUPTOR CLAUSOR
 G.M.—OPEL
 90505912

IE-2518
 INTERRUPTOR CLAUSOR
 FIAT—PSA
 1329316080



IE-2523
 INTERRUPTOR CLAUSOR
 GRUPO VAG
 7E0 905 865 / 6R0 905 865

IE-2524
 INTERRUPTOR CLAUSOR
 GRUPO VAG
 5Q0 905 849 / 5Q0905849 C



IE-2525
 INTERRUPTOR CLAUSOR
 MERCEDES VITO
 0005458108 (ANTES: IE-5525)

IE-2582
 INTERRUPTOR CLAUSOR
 G.M.—CHEVROLET
 96238726





IM-001
 INTERRUPTOR LUCES
 G.M.—OPEL
 CORSA A / FRONTERA
 1240501
 9036152439
 *HASTA AGOTAR EXISTENCIAS

IM-320
 INTERRUPTOR LUCES
 VW
 PASSAT / GOLF / JETTA
 191 941 531 H
 8 PINS
 *HASTA AGOTAR EXISTENCIAS



IM-370
 INTERRUPTOR LUCES
 G.M. OPEL
 ASTRA / CORSA / TIGRA
 1240126
 *HASTA AGOTAR EXISTENCIAS

IM-527
 INTERRUPTOR LUCES
 VW POLO
 6N1 941 531 J
 14 PINS
 *HASTA AGOTAR EXISTENCIAS



IM-558
 INTERRUPTOR LUCES
 G.M. OPEL
 ASTRA G
 6240097—60437439

IM-570
 INTERRUPTOR LUCES
 VW / SEAT
 C/ ANTINIEBLA DELANTERO
 1C0 941 531 A



IM-993
 INTERRUPTOR LUCES
 AUDI TT 96'-06'
 8N1 941 531 A
 ORIGINAL AUDI

IM-2440
 INTERRUPTOR LUCES
 VW GOLF MK5 / CADDY / EOS /
 PASSAT / TOURAN
 C/ ANTINIEBLA DELANTERO
 1K0 941 431 C / Q / AJ



IM-2453
 INTERRUPTOR LUCES
 VW GOLF MK5 / CADDY / EOS /
 PASSAT / TOURAN
 C/ ANTINIEBLA DELANTERO
 C/ LUZ AUTOMATICAS
 1K0 941 431 N

IM-2511
 INTERRUPTOR LUCES
 OPEL ASTRA
 13 129 254



IM-2520
 INTERRUPTOR LUCES
 VW GOLF MK5 / MK6 / CADDY /
 EOS / PASSAT / TOURAN
 C/ ANTINIEBLA DELANTERO
 5ND 941 431 A

IM-2601
 INTERRUPTOR LUCES
 SKODA OCTAVIA 2 (1Z)
 ILUMINACION VERDE
 1K0 941 431 / A / E





IM-006

PULSADOR ELEVANUNAS
FORD ESCORT FIESTA -
95'



IM-043

PULSADOR ELEVANUNAS
VW SHARAN / SEAT ALHAMBRA / F. GALAXY
7M0955959A / 95vw14529daw



IM-201

CONMUTADOR ELEVANUNAS
G.M.- OPEL ASTRA LADO IZQ
6240107 / 09100301



IM-401

CONMUTADOR ELEVANUNAS
OPEL ASTRA LADO IZQ 4 VEN-
TA.



IM-728

PULSADOR ELEVANUNAS
VW GOLF MK2 / JETTA MK2
191 959 855



IM-869

PULSADOR ELEVANUNAS
SEAT TOLEDO
1L0 959 855



IM-916

PULSADOR ELEVANUNAS
VW GOLF MK3 PUERTA DRCH
1H0 959 855 C



IM-917

CONMUTADOR ELEVANUNAS
VW GOLF MK3 PUERTAS TRAS.
1H0 959 855 A



IM-991

CONMUTADOR ELEVANUNAS
VW GOLF MK3 PUERTA DRCH.
1H0 959 855



IM-2220

CONMUTADOR ELEVANUNAS
FORD FIESTA / KA / PUMA
1007910



IM-2221

INTERRUPTOR ELEVANUNAS
FORD FIESTA / KA/ PUMA
1006292



IM-2268

CONMUTADOR ELEVANUNAS
GRUPO VAG 99'-06'
1J4 959 857



IM-2269

CONMUTADOR ELEVANUNAS
GRUPO VAG 06'-15'
1K4 959 857 B



IM-2281

PULSADOR ELEVANUNAS
FORD TRANSIT MK7 DEL. DRCH.
1383293



IM-2286

PULSADOR ELEVANUNAS
FORD ESCORT PUERTA DRCH.
1027749



IM-2314

PULSADOR ELEVANUNAS
BMW SERIE 3 E36 / Z3
61311387916



IM-2315
 CONMUTADOR ELEVACIONES
 VW POLO 9N / IBIZA 6L
 C/ CONFORT 6Q0 959 858



IM-2332
 PULSADOR ELEVACIONES
 VW PASSAT B6 / B7 TOURAN
 5K0 959 855 / 5ND9 659 855



IM-2335
 CONMUTADOR ELEVACIONES
 VW POLO 9N / IBIZA 6L
 S/ CONFORT 6Q0 959 858



IM-2386
 PULSADOR ELEVACIONES
 SKODA FABIA
 6Y0 959 855



IM-2404
 CONMUTADOR ELEVACIONES
 GRUPO VAG
 1K3 959 857 / 2K0 959 857



IM-2405
 PULSADOR ELEVACIONES
 AUDI A4 / S4 / TT / R8
 8E0 959 855A



IM-2408
 CONMUTADOR ELEVACIONES
 PSA / FIAT
 6490.X8 / 735487419



IM-2409
 CONMUTADOR ELEVACIONES
 VW GOLF MK4 / LEON MK1
 1J3 959 857



IM-2412
 PULSADOR ELEVACIONES
 AUDI A3 / A6 / Q7
 4F0 959 855



IM-2420
 INTERRUPTOR ELEVACIONES
 BMW
 6131945874



IE-2422
 CONMUTADOR ELEVACIONES
 RENAULT
 8200060045



IM-2439
 CONMUTADOR ELEVACIONES
 PSA FIAT
 6554.W9



IM-2449
 PULSADOR ELEVACIONES
 GRUPO VAG
 6X0 959 855 B



IM-2482
 PULSADOR ELEVACIONES
 RENAULT
 7700838100



IM-2483
 PULSADOR ELEVACIONES
 RENAULT PUERTA DEL. IZQ.
 7700838101



IM-2484
 PULSADOR ELEVACIONES
 RENAULT PUERTA DEL. DRCH.
 7700838098



IM-034
 INTERRUPTOR WARNING
 VW PASSAT 3B
 3B0 953 235 D / B



IM-045 (IM-2180)
 INTERRUPTOR WARNING
 AUDI A3 8L
 8L0 941 509 G



IM-049
 INTERRUPTOR WARNING
 SKODA OCTAVIA MK1 2ª FASE
 1U0 953 235 B



IM-058
 INTERRUPTOR WARNING
 SKODA OCTAVIA 1ª FASE
 1U0 953 235 F



IM-060
 INTERRUPTOR WARNING
 AUDI A4
 8D0 941 509 H



IM-090
 INTERRUPTOR WARNING
 VW GOLF MK4
 1J0 953 235 J



IM-150
 INTERRUPTOR WARNING
 FORD FOCUS
 98AG13A350AE / 1112004



IM-158
 INTERRUPTOR WARNING
 RENAULT TWINGO 1ª SERIE
 7700821551 / 7700822 444



IM-179
 INTERRUPTOR WARNING
 OPEL ASTRA G
 6240137



IM-279
 INTERRUPTOR WARNING
 PEUGEOT 607
 96296484



IM-288
 INTERRUPTOR WARNING
 OPEL CORSA
 1241661



IM-289
 INTERRUPTOR WARNING
 OPEL ASTRA
 09138044 (= IM-290)



IM-332
 INTERRUPTOR WARNING
 GRUPO VAG
 6N0 953 235



IM-421
 INTERRUPTOR WARNING
 CITRÖEN C5
 6554.A0 96323950



IM-451
 INTERRUPTOR WARNING
 OPEL CORSA B
 9138045

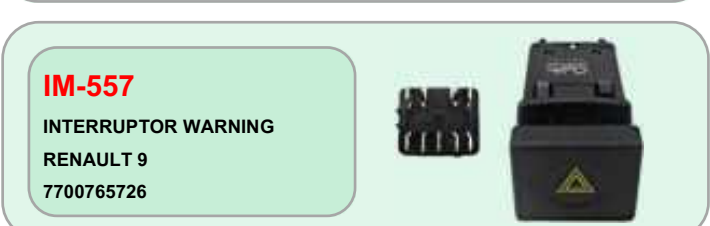

IM-557
 INTERRUPTOR WARNING
 RENAULT 9
 7700765726



IM-631
 INTERRUPTOR WARNING
 SEAT IBIZA / CORDOBA 99-02
 6K0 953 235



IM-707
 INTERRUPTOR WARNING
 SEAT IBIZA / CORDOBA 02-09
 6L1 953 235 A



IM-894
 INTERRUPTOR WARNING
 OPEL CALIBRA
 1241656 90316901



IM-906
 INTERRUPTOR WARNING
 OPEL CORSA A
 1241658 / 90310998



IM-920
 INTERRUPTOR WARNING
 OPEL ASTRA F



IM-2060
 INTERRUPTOR WARNING
 VOLVO V.I.
 1096414



IM-2162
 INTERRUPTOR WARNING
 MERCEDES BENZ V.I.
 0074543824



IM-2255
 INTERRUPTOR WARNING
 VW PASSAT / CC
 3C0 953 509 A



IM-2334
 INTERRUPTOR WARNING
 RENAULT CLIO 2
 8200060036



IM-2399
 INTERRUPTOR WARNING
 VW GOLF MK5 / MK6
 1K0 953 509 A



IM-2415
 INTERRUPTOR WARNING
 AUDI A6
 4B0 941 509 / C / D / K



IM-2451
 INTERRUPTOR WARNING
 RENAULT VARIOS
 8200442724



IM-2462
 INTERRUPTOR WARNING
 SKODA FABIA / VW T5
 6Y0953235



IM-2509
 INTERRUPTOR WARNING
 PEUGEOT 206
 6554.L0



IM-2529
 INTERRUPTOR WARNIN
 RENAULT KANGOO
 7700308821



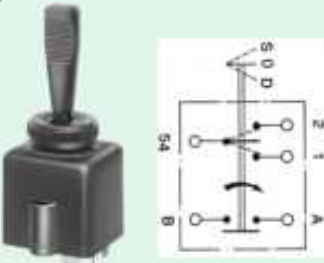

IM-2558
 INTERRUPTOR WARNING
 RENAULT CLIO FASE 2
 7700421820





COBO® 15.104.000
CONMUTADOR INTERMITENTES
RAFAGAS
ON - OFF - ON - ON - (ON)
12/24V 8,5/5A
5 FASTON 6,3

15.110.000 COBO®
INTERRUPTOR STOP
DESVIADOR
15.105.000
OFF - ON
3 FASTON 6,3

COBO® 15.111.000
CONMUTADOR INTERMITENTES
ON - OFF - ON
12/24V 8,5/5A
3X FASTON 6,3
MANGO CORTO

15.112.000 COBO®
CONMUTADOR
ON - OFF
12/24V 8,5/5A
3 FASTON 6,3

COBO® 15.115.11
CONMUTADOR INTERMITENTES
RAFAGAS
ON - OFF - ON - ON - (ON)
12/24V 8,5/5A
5 FASTON 6,3

15.117.000 COBO®
INTERRUPTOR STOP
DESVIADOR
OFF - ON
4 FASTON 6,3
= 15.0160.0000

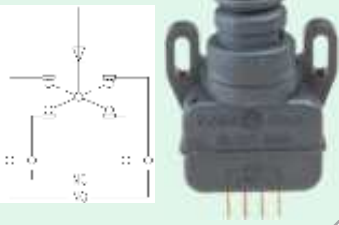
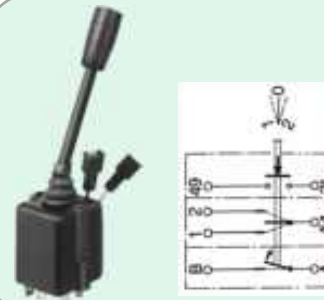

COBO® 15.119.000
CONMUTADOR
INTERMITENTES
RAFAGAS
ON - OFF - ON - ON - (ON)
12/24V 8,5/5A
5 FASTON 6,3

15.133.000 COBO®
INTERRUPTOR STOP
DESVIADOR
OFF - ON
CONECTOR SEAL 3 CABLES





COBO® 15.155.000
CONMUTADOR INTERMITENTES
ON - OFF - ON
12/24V 8,5/5A
3X FASTON 6,3
MANGO LARGO

15.0160.0000 COBO®
INTERRUPTOR STOP
DESVIADOR
OFF - ON
4 FASTON 6,3
= 15.117.000

COBO® 15.0167.0000
INTERRUPTOR STOP
DESVIADOR
OFF - ON
CONECTOR SEAL 4 CABLES

16.182.000 COBO®
CONMUTADOR A PEDAL
PASO A PASO
3 FASTON 6,3
CAMBIO DE LUCES





COBO® 16.191.000
CONMUTADOR DESVIADOR
 ON - ON
 12/24V 8,5/5A
 3 FASTON 6,3



16.193.000 COBO®
CONMUTADOR COMANDO
ELEVACIÓN ELECTRONICO
 12/24V
 6 FASTON 6.3 + SEAL 2 VIAS



COBO® 16.200.000
CONMUTADOR DESVIADOR
 (ON) - (ON)
 12/24V 20/15A
 6 FASTON 6,3

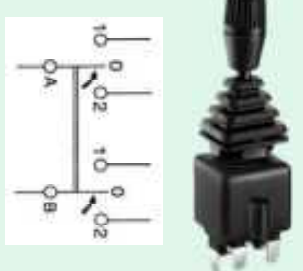

16.203.000 COBO®
CONMUTADOR DESVIADOR
DOBLE
 12V / 24V
 6 FASTON 6.3



COBO® 17.111.000
INTERRUPTOR SEGURIDAD
 Ø M16X2
 2 FASTON
CONTACTO ABIERTO
 12V / 20AMP
 24V / 10AMP



17.113.000 COBO®
INTERRUPTOR SEGURIDAD
 Ø M16X2
 2 FASTON
CONTACTO CERRADO
 12V / 45A
 24V / 20A



COBO® 17.122.000
INTERRUPTOR SEGURIDAD
 Ø M16X1.5
 4 FASTON
 12V / 25 AMP
 24V / 15 AMP



17.130.000 COBO®
PULSADOR UNIVERSAL
 12V 25AMP
 24V 15AMP
 Ø22.5mm
 2 FASTON 6,3



COBO® 17.134.000
PULSADOR UNIVERSAL
 12V 25AMP
 24V 15AMP
 Ø22.5mm
 2 FASTON 6,3
ESPECIAL CLAXÓN



17.160.000 COBO®
CONMUTADOR STOP PULSANTE
 ON- (ON)
 4 FASTON 6,3



COBO® 17.161.000
CONMUTADOR STOP PULSANTE
 ON- (ON)
 2 FASTON 6,3
CONTACTO ABIERTO



17.162.000 COBO®
CONMUTADOR STOP PULSANTE
 ON- (ON)
 4 FASTON 6,3
CONTACTO CERRADO

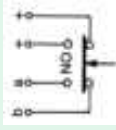

COBO® 17.168.000

INTERRUPTOR SEGURIDAD
Ø M16X1
4 FASTON
12V / 25 AMP
24V / 15 AMP

17.169.000 COBO®

INTERRUPTOR PEDAL
12V 4AMP
24V 2AMP
CONTACTO CERRADO

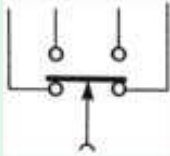

COBO® 17.170.000

CONMUTADOR PULSANTE
ØM16X1,5
4 FASTON 6,3

17.171.000 COBO®

PULSADOR PEDAL
REFORZADO
M16X1,5
12V / 45AMP
24V / 25AMP

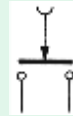

COBO® 17.173.000

INTERRUPTOR PEDAL
12V 4AMP
24V 2AMP
CONTACTO ABIERTO

17.204.000 COBO®

INTERRUPTOR MARCHA ATRÁS
DOBLE TUERCA
12V / 8 AMP
24V / 4 AMP

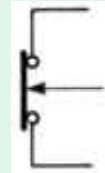

COBO® 17.205.000

CONMUTADOR STOP PULSANTE
ON- (ON)
4 FASTON 6,3

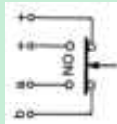

IP-0302

PULSADOR GOMA
CONEXIÓN TORNILLO
Ø 22mm

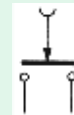

IP-0201

PULSADOR ROJO
CONEXIÓN TORNILLO
Ø 22mm



30.34.10091

PULSADOR SEGURIDAD
REARME MANUAL
IP66

30.34.10091A

PULSADOR SEGURIDAD
VERSION ALTERNATIVA

30.34.10308 COBO®

INTERRUPTOR PALANCA
12 VIAS
FASTON 6,3

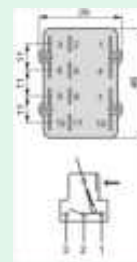

IR-0581

INTERRUPTOR C/LED
12V / 24V
TIPO "TOP GUN"
TAPA INCLUIDA

00.9005-R

TAPA SEGURIDAD ROJA



00.9005-A

TAPA SEGURIDAD AMARILLA





IR-2700

INTERRUPTOR REFORZADO
ON - OFF
20/10A 2 FASTON 6,3

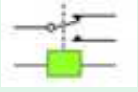

IR-2701

INTERRUPTOR PULSADOR REFORZADO
ON—(ON)
20/10A 3 FASTON 6,3

IR-2702

INTERRUPTOR REFORZADO
ON - ON
20/10A 3 FASTON 6,3

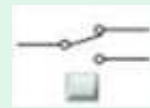

IR-2704

INTERRUPTOR REFORZADO
ON—OFF—ON
20/10A 3 FASTON 6,3

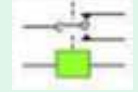
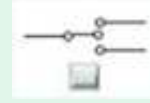

IR-2706

PULSADOR CONMU. REFORZADO
(ON) - OFF—(ON)
20/10A 3 FASTON 6,3



IR-2710

INTERRUPTOR REFORZADO
ON—OFF
20/10A 4 FASTON 6,3

IR-2712

INTERRUPTOR REFORZADO
ON - ON
20/10A 6 FASTON 6,3



IR-2714

INTERRUPTOR REFORZADO
ON—OFF—ON
20/10A 6 FASTON 6,3



IR-2716

PULSADOR CONMU. REFORZADO
(ON) - OFF—(ON)
20/10A 6 FASTON 6,3



IR-2001

TUERCA DE GOMA
PARA INTERRUPTORES
M12X0,75

IT-0007

INTERRUPTOR C/LED
OFF - ON
20/10A 3 FASTON 6,3



IT-0011

INTERRUPTOR SIN LUZ
ON—OFF
20/10A 2 FASTON 6,3

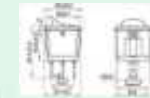

PG-0026

PULSADOR ARRANQUE
REFORZADO
12/24 VOLS
CONEXIÓN TORNILLO

IP-0101

INTERRUPTOR DE FRENO
CONTACTO CERRADO



IP-0102

INTERRUPTOR DE FRENO
CONTACTO CERRADO
CON SOPORTE



IP-0510

PULSADO DE PIE
CONEXIÓN TORNILLO
HELLA 6EJ001569001

IT-0103

INTERRUPTOR TIRÓN
CUELLO CORTO
CONEXIÓN TORNILLOS
12/24V 10/20 AMPS



IT-0108

INTERRUPTOR TIRÓN
CUELLO LARGO
CONEXIÓN TORNILLOS
12/24V 10/20 AMPS

IR-0006

INTERRUPTOR EXTERIOR
CON CAJA ESTANCA IP67
OFF-ON





470004
 TENSIÓN: 12/24V.
 POSICIONES : 0-1-2
 TERMINALES FASTON
 TUERCA M22x1
 CONTACTO - ARRANQUE
 V = LLAVES VARIADAS
 I = LLAVES IGUALES



470007
 TENSIÓN: 12/24V.
 POSICIONES : 0-1-2-3
 TERMINALES FASTON
 TUERCA M19,5x8
 CONTAC-PRECAL.-ARRANQUE
 V = LLAVES VARIADAS
 I = LLAVES IGUALES

471007 ANTI-REPETITIVO
 TENSIÓN: 12/24V.
 POSICIONES : 0-1-2-3
 TERMINALES FASTON
 TUERCA M19,5x8
 CONTAC-PRECAL.-ARRANQUE
 V = LLAVES VARIADAS
 I = LLAVES IGUALES



470008
 TENSIÓN: 12/24V.
 POSICIONES : 0-1-2-3
 TERMINALES FASTON
 TUERCA M16x1
 CONTAC-PRECAL.-ARRANQUE
 I = LLAVES IGUALES

470009
 TENSIÓN: 12/24V.
 POSICIONES : 0-1-2-3
 TERMINALES FASTON
 TUERCA M19,5x8
 CONTAC-PRECAL.-ARRANQUE
 I = LLAVES IGUALES



470013
 TENSIÓN: 12/24V.
 POSICIONES : 0-1
 TERMINALES FASTON
 TUERCA M22x1
 CONTACTO
 V = LLAVES VARIADAS
 I = LLAVES IGUALES

470014
 TENSIÓN: 12/24V.
 POSICIONES : 0-1-2
 TERMINALES FASTON
 TUERCA M22x1
 CONTACTO - ARRANQUE
 V = LLAVES VARIADAS
 I = LLAVES IGUALES



470520
 TENSIÓN: 12/24V.
 POSICIONES : 0-1
 TERMINALES FASTON
 TUERCA M22x1
 CONTACTO
 I = LLAVES IGUALES
TRABAJO INTEMPERIE

475520
 TENSIÓN: 12/24V.
 POSICIONES : 0-1-2
 TERMINALES FASTON
 TUERCA M22x1
 CONTACTO - ARRANQUE
 I = LLAVES IGUALES
TRABAJO INTEMPERIE



471308
 TENSIÓN: 12/24V.
 POSICIONES : 0-1-2
 TERMINALES FASTON
 TUERCA M16x1
 CONTAC-ARRANQUE
POMO ROJO

471408
 TENSIÓN: 12/24V.
 POSICIONES : 0-1-2-3
 TERMINALES FASTON
 TUERCA M19,5x8
 CONTAC-PRECAL.-ARRANQUE
POMO ROJO



LLAVES DE CONTACTO



473810

TENSIÓN: 12/24V.
 POSICIONES : 0-1-2
 TORNILLO
 TUERCA M22x1
 CONTACTO - ARRANQUE



471503

TENSIÓN: 12/24V.
 POSICIONES : 0-1-2
 TERMINALES FASTON - IP67
 TUERCA M22x1
 CONTACTO 1 - CONTACTO 2
 I = LLAVES IGUALES
 LINDE 79154992621

471717

TENSIÓN: 12/24V.
 POSICIONES : 0-1-2
 TERMINALES FASTON
 TUERCA Ø 24 mm
 CONTACTO- ARRANQUE
 JOND DEERE
 RE61717-RE48214-RE56411





472020

TENSIÓN: 12/24V.
 POSICIONES : 0-1-2-3
 TERMINALES FASTON - IP67
 TUERCA M22x1
 CONTACT- PRECAL-ARRANQUE
 I = LLAVES IGUALES
 ANTI-REPETICIÓN

472775

TENSIÓN: 12/24V.
 POSICIONES : P-0-1-2
 TERMINALES FASTON
 TUERCA Ø 24 mm
 CONTACT - ARRANQUE
 CASE - NEW HOLLAND
 282775A1





474018-I

TENSIÓN: 12/24V.
 POSICIONES : P-0-1-2-3
 TERMINALES FASTON
 TUERCA M22x1
 CONTACT - PRECAL. - ARRANQUE
 JCB 701 / 80184
 ANT-REPETICIÓN - IP65

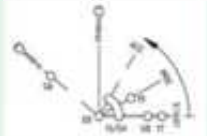

474018-G.I

TENSIÓN: 12/24V.
 POSICIONES : P-0-1-2-3
 TERMINALES FASTON
 TUERCA M22x1
 CONTACT - PRECAL - ARRANQUE
 JCB 701 / 80184
 ANT-REPETICIÓN - IP65



474041-G.I

TENSIÓN: 12/24V.
 POSICIONES : P-0-1-2-3
 TERMINALES FASTON
 TUERCA M22x1
 PARKING - CONTACTO -ARRANQUE
 IP65
 REF OE 1532372C2 SAME





475963

TENSIÓN: 12/24V.
 POSICIONES : P-0-1-2
 TERMINALES FASTON
 TUERCA M22x1
 CONTACTO - ARRANQUE
 JOND DEERE
 RE45963





478020

TENSIÓN: 12/24V.
 POSICIONES : 0-1-2
 TERMINALES FASTON
 TUERCA M22x1
 CONTACTO - ARRANQUE
 I = LLAVES IGUALES
 IP67 - ANTI - REOETICIÓN

11101255

TENSIÓN: 12/24V.
 POSICIONES : 0-1-2-3
 TERMINALES FASTON
 TUERCA M22x1
 CONTACTO - PREC - ARRANQUE
 I = LLAVES IGUALES
 TIPO BOSCH





11106801

TENSIÓN: 12/24V.
POSICIONES : PRE-0-1-2
TERMINALES FASTON
TUERCA Ø 19,5 x 1
CONTACTO - ARRANQUE
PRECALENTAMIENTO
KUBOTA 4310770

11107202

TENSIÓN: 12/24V.
POSICIONES : 0-1-2
TERMINALES FASTON
TUERCA Ø 19,5 x 1
CONTACTO - ARRANQUE
MASSEY FERGUSON
922201M92



COBO® 14.0312.0000

TENSIÓN: 12/24V. MAX 30 A
POSICIONES : 0-1-2
TERMINALES FASTON
TUERCA Ø 22,5 mm
CONTACTO - ARRANQUE
ANTI - REPETICIÓN

14.0313.00000 COBO®

TENSIÓN: 12/24V. MAX 30 A
POSICIONES : 3-0-1-2
TERMINALES FASTON
TUERCA Ø 22,5 mm
CONTACTO - ARRANQUE
INTEMPERIE
ANTI - REPETICIÓN



COBO® 14.0322.0000

TENSIÓN: 12/24V. MAX 30 A
POSICIONES : P-0-1-2-3
TERMINALES FASTON
TUERCA Ø 25 mm
CONTACTO - ARRANQUE - PREC
ANTI - REPETICIÓN

14.0325.0000 COBO®

TENSIÓN: 12/24V. MAX 30 A
POSICIONES : 0-1-2-3 - 4
TERMINALES FASTON
TUERCA Ø 25 mm
CONTACTO - ARRANQUE - PREC
ANTI - REPETICIÓN



COBO® 14.0352.0000

TENSIÓN: 12/24V. MAX 30 A
POSICIONES : 0-1-2
TERMINALES FASTON
TUERCA Ø 25 mm
CONTACTO - ARRANQUE
ANTI - REPETICIÓN



COBO® 14.0376.0000

TENSIÓN: 12/24V. MAX 30 A
POSICIONES : 0-1-2-3
TERMINALES FASTON
TUERCA Ø 25 mm
CONTACTO-ARRANQUE-PREC
ANTI-REPETICIÓN

14.0404.0000 COBO®

TENSIÓN: 12/24V. MAX 30 A
POSICIONES : 0-1-2-3 - 4
TERMINALES FASTON
TUERCA Ø 25 mm
CONTACTO - ARRANQUE - PREC
SIN LLAVES SOLO BOMBIN
LLAVES ORIGINALES
CATERPILLAR



COBO® 14.109.000

TENSIÓN: 12/24V.
POSICIONES : 0 -1 - 2
TERMINALES FASTON
TUERCA Ø 22,5 mm
CONTACTO - ARRANQUE

14.110.000 COBO®

TENSIÓN: 12/24V.
POSICIONES : P -0-1-2
TERMINALES FASTON
TUERCA Ø 22,5 mm
CONTACTO - ARRANQUE
(CON PARKING)





COBO® 14.111.000
 TENSIÓN: 12/24V.
 POSICIONES : 0-1-2
 TERMINALES FASTON
 TUERCA Ø 22,5 mm
 CONTACTO - ARRANQUE



14.115.000 COBO®
 TENSIÓN: 12/24V.
 POSICIONES : P - 0-1-2
 TERMINALES FASTON
 TUERCA Ø 22,5 mm
 CONTACTO - ARRANQUE
 PRECALENTAMIENTO



COBO® 14.119.11
 TENSIÓN: 12/24V.
 POSICIONES : P - 0-1-2
 TERMINALES FASTON
 TUERCA Ø 22,5 mm
 CONTACTO - ARRANQUE



14.120.11 COBO®
 TENSIÓN: 12/24V.
 POSICIONES : P - 0-1-2
 TERMINALES FASTON
 TUERCA Ø 22,5 mm
 CONTACTO - ARRANQUE
 PRECALENTAMIENTO



COBO® 14.122.11
 TENSIÓN: 12/24V.
 POSICIONES : 0-1
 TERMINALES FASTON
 TUERCA Ø 22,5 mm
 CONTACTO



14.124.11 COBO®
 TENSIÓN: 12/24V.
 POSICIONES : 3 - 0 - 1 - 2
 TERMINALES FASTON
 TUERCA Ø 22,5 mm
 CONTACTO - ARRANQUE



COBO® 14.130.11
 TENSIÓN: 12/24V. MAX 30 A
 POSICIONES : 0-1-2-3
 TERMINALES FASTON
 TUERCA Ø 22,5 mm
 CONTACTO - ARRANQUE
 PRECALENTAMIENTO



14.132.000 COBO®
 TENSIÓN: 12/24V.
 POSICIONES : P - 0 - 1 - 2 -
 TERMINALES FASTON
 TUERCA M22x1
 PARKING - CONTACTO - ARRANQUE
 IP65



COBO® 14.134.000
 TENSIÓN: 12/24V. MAX 30 A
 POSICIONES : 0-1-2
 TERMINALES FASTON
 TUERCA Ø 22,5 mm
 CONTACTO - ARRANQUE



14.135.000 COBO®
 TENSIÓN: 12/24V. MAX 30 A
 POSICIONES : P - 0-1-2-
 TERMINALES FASTON
 TUERCA Ø 22,5 mm
 CONTACTO - ARRANQUE - PREC
 LLAVES ORIGINALES



COBO® 14.136.000
 TENSIÓN: 12/24V.
 POSICIONES : 0 - 1 - P - 2
 TERMINALES FASTON
 TUERCA Ø 22,5 mm
 CONTACTO - ARRANQUE
 PRECALENTAMIENTO



14.138.000 COBO®
 TENSIÓN: 12/24V.
 POSICIONES : 0 - 1
 TERMINALES FASTON
 TUERCA Ø 22,5 mm
 CONTACTO

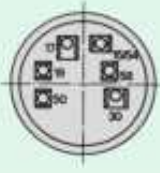

COBO® 14.156.11
 TENSIÓN: 12/24V.
 POSICIONES : P-0-1-2
 TERMINALES FASTON
 TUERCA Ø 22,5 mm
 CONTACTO - ARRANQUE
 PRECALENTAMIENTO

14.159.11 COBO®
 TENSIÓN: 12/24V.
 POSICIONES : P - 0-1-2
 TERMINALES FASTON
 TUERCA Ø 22,5 mm
 PARKING - CONTACTO
 - ARRANQUE

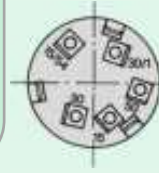

COBO® 14.163.11
 TENSIÓN: 12/24V.
 POSICIONES : 0-1-2
 TERMINALES FASTON
 TUERCA Ø 22,5 mm
 CONTACTO - ARRANQUE

14.173.11 COBO®
 TENSIÓN: 12/24V.
 POSICIONES : 0-1-2-3
 TERMINALES FASTON
 TUERCA Ø 22,5 mm
 CONTACTO - ARRANQUE
 PRECALENTAMIENTO



COBO® 14.188.000
 TENSIÓN: 12/24V.
 POSICIONES : 1-2-3-4
 TERMINALES FASTON
 TALADR Ø 16 mm
 CONTACTO - SERVICIOS
 PRECALENTAMIENTO -
 ARRANQUE

14.300.000 COBO®
 TENSIÓN: 12/24V.
 POSICIONES : 3 - 0 - 1 - P - 2
 TERMINALES FASTON
 TUERCA Ø 22,5 mm
 CONTACTO - ARRANQUE
 PRECALENTAMIENTO



COBO® 14.301.000
 TENSIÓN: 12/24V.
 POSICIONES : 0-1-2
 TERMINALES FASTON
 TUERCA Ø 22,5 mm
 CONTACTO - ARRANQUE

14.303.000 COBO®
 TENSIÓN: 12/24V.
 POSICIONES : 0-1-P-2
 TERMINALES FASTON
 TUERCA Ø 22,5 mm
 CONTACTO - ARRANQUE
 PRECALENTAMIENTO

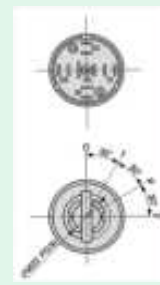
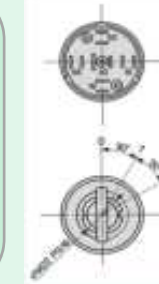

COBO® 14.307.000
 TENSIÓN: 12/24V.
 POSICIONES : 0-1-P-2
 TERMINALES FASTON
 TUERCA Ø 22,5 mm
 CONTACTO - ARRANQUE
 PRECALENTAMIENTO

14.109.108 COBO®
 LLAVE RECAMBIO



14.100.050 COBO®
 LLAVE RECAMBIO



COBO® 14.109.500
 PROTECTOR LLAVE
 Ø 22,5 mm

14.0322.0500 COBO®
 PROTECTOR LLAVE
 Ø 26,5 mm





U06000002 (12V)
U06000012 (24V)
INDICADOR DE COMBUSTIBLE
TIPO VEGLIA
Ø 52 mm

U06000003 (12V)
U06000013 (24V)
INDICADOR TEMPERATURA AGUA
TIPO VEGLIA 120°
Ø 52 mm











U06000004 (12V)
U06000014 (24V)
INDICADOR TEMPERATURA ACEITE
150° TIPO VEGLIA
Ø 52 mm



U06000077 (12V/24V)
CUENTA HORAS
Ø 52 mm

U07500101 (12V)
CUENTA REVOLUCIONES
3000 RPM + CUENTA HORAS
Ø 85 mm

U07500102 (24V)
CUENTA REVOLUCIONES
3000 RPM + CUENTA HORAS
Ø 85 mm



U07500103 (12V)
CUENTA REVOLUCIONES
4000 RPM + CUENTA HORAS
Ø 85 mm

U07500104 (24V)
CUENTA REVOLUCIONES
4000 RPM + CUENTA HORAS
Ø 85 mm







U08020034 (24V)
CUADRO COMBINADO
CUENTA HORAS
INDICADOR COMBUSTIBLE
+ 9 LUCES DE CONTROL
Ø 100 mm

U08020035 (24V)
CUADRO COMBINADO
CUENTA HORAS
INDICADOR TEMP. HIDRAULICA
+ 9 LUCES DE CONTROL
Ø 100 mm







06200002 (10/80V)
CUENTA HORAS
36,4mm x 23,4mm

06210005 (4.5V/60V)
CUENTA HORAS DIGITAL
IP67
CONEX. FASTON
54X31 mm

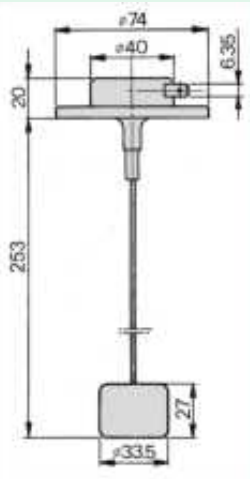

29.041.000

INTERRUPTOR NIVEL
CARBURANTE
CONTACTO CERRADO
2 FASTON 6,3
VARILLA 253mm

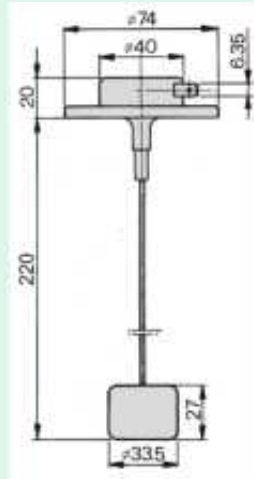

29.047.000

INTERRUPTOR NIVEL
CARBURANTE
CONTACTO CERRADO
2 FASTON 6,3
VARILLA 220mm

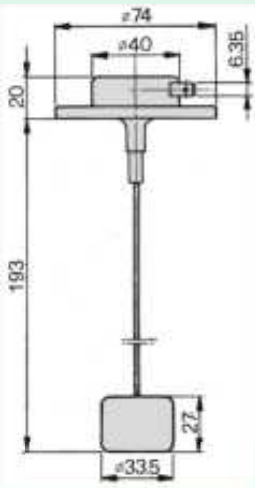

29.051.000

INTERRUPTOR NIVEL
CARBURANTE
CONTACTO CERRADO
2 FASTON 6,3
VARILLA 193mm

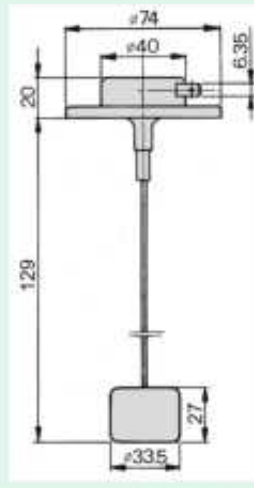

29.054.000

INTERRUPTOR NIVEL
CARBURANTE
CONTACTO CERRADO
2 FASTON 6,3
VARILLA 129mm

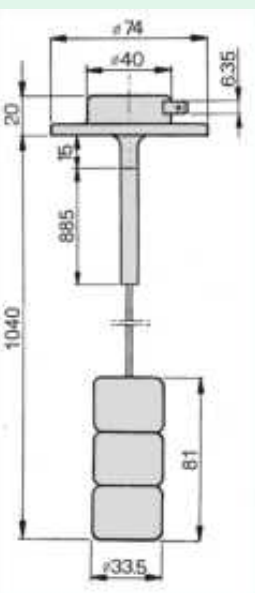

29.063.000

INTERRUPTOR NIVEL
CARBURANTE
CONTACTO CERRADO
2 FASTON 6,3
VARILLA 1040mm

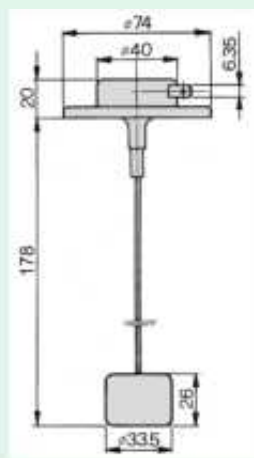

29.118.000

INTERRUPTOR NIVEL
CARBURANTE
CONTACTO CERRADO
2 FASTON 6,3
VARILLA 178mm



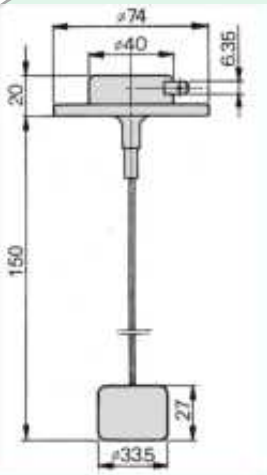

29.142.000

INTERRUPTOR NIVEL
CARBURANTE
CONTACTO CERRADO
2 FASTON 6,3
VARILLA 150mm

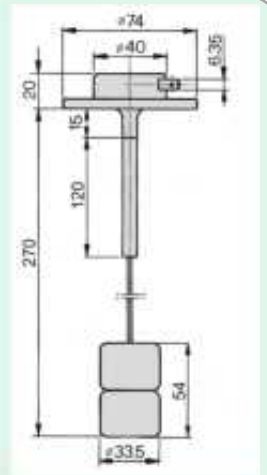

29.258.000

INTERRUPTOR NIVEL
CARBURANTE
CONTACTO CERRADO
2 FASTON 6,3
VARILLA 220mm

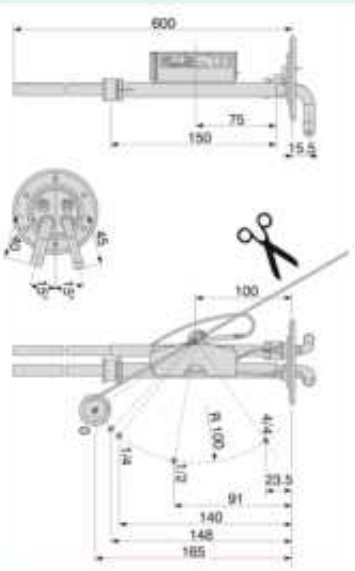

29.0492.000

AFORADOR COMBU.
UNIVERSAL
C/ LUZ DE RESERVA
2 TUBOS AJUSTABLES
RETORNO
VARILLA RECORTABLE
UNIDEK
RESISTENCIA VEGLIA
2 FASTON 6,3
12V/24V

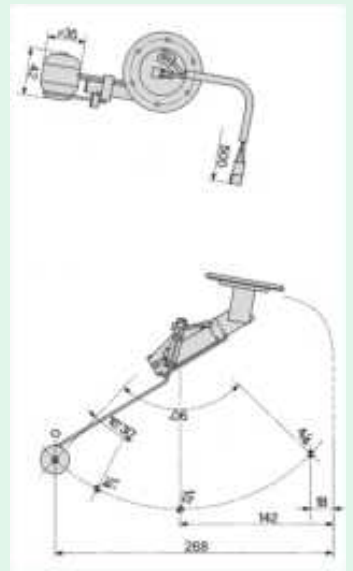

29.087.000

AFORADOR COMBU.
CASE-IH
NEW HOLLAND
FIAT
5140580

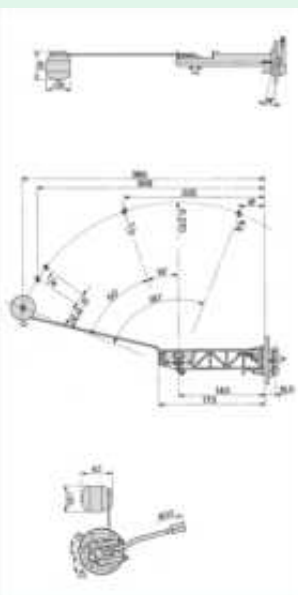

29.088.000

AFORADOR COMBU.
CASE-IH
NEW HOLLAND
FIAT
ESP-8031
403.00.56.03
35581
5136771

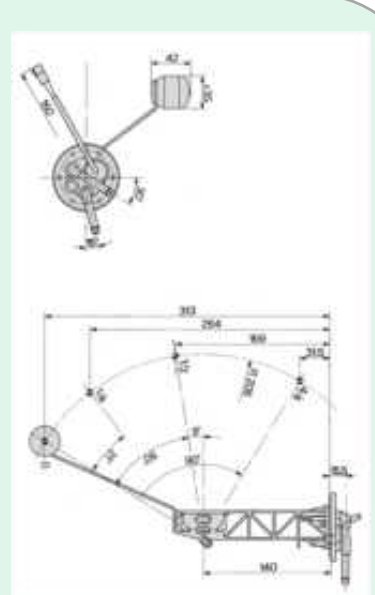

29.089.000

AFORADOR COMBU.
CASE-IH
NEW HOLLAND
FIAT
5136770



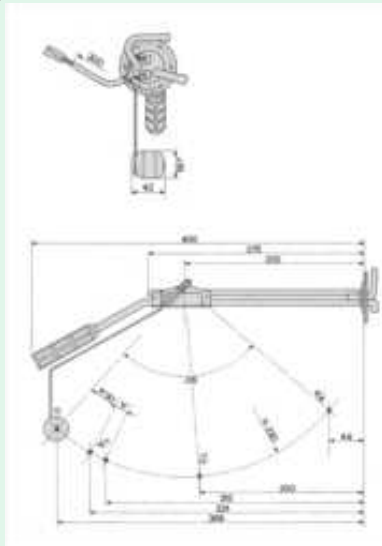

29.127.000

AFORADOR COMB.

SAME

2.7059.430.0/01

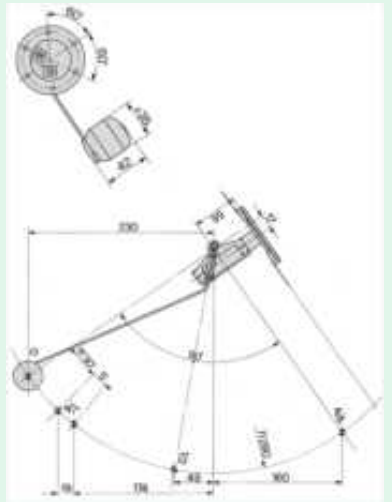

29.162.000

AFORADOR COMBU.
CON RESERVA
CONECTOR 3 CABLES

1029182

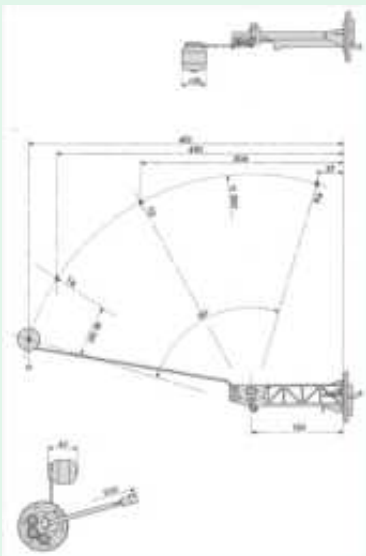

29.211.000

AFORADOR COMBU.

CASE-IH
NEW HOLLAND
FIAT

5150091
ESP-55021

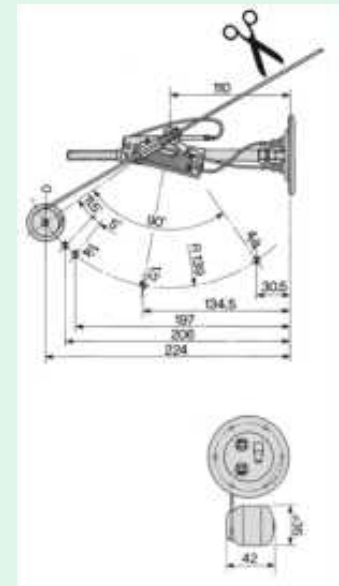

29.240.000

AFORADOR COMBU.

CASE-IH
CASE
FENDT

130815
136842
077-021
6000105103

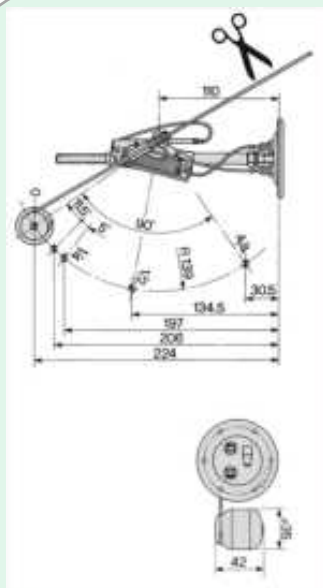

29.241.000

AFORADOR COMBU.

UNIVERSAL

G080329

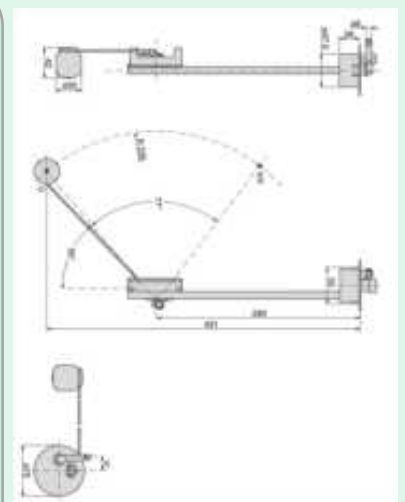

29.385.000

AFORADOR COMBU.

CASE-IH
NEW HOLLAND
FIAT

5194712



CONSULTAR DISPONIBILIDAD ***

A-1001	470202	SEAT 600 D - E - L
A-1003	470223	SEAT 133
A-1005	470229	SEAT 127
A-1009	470207	SEAT 124 FAMILIAR
A-1010	470211	SEAT 124 / 1430 2T
A-1014	470225	SEAT 131 FAMILIAR
A-1016	470241	SEAT RITMO
A-1019	470255	SEAT PANDA-MARBELLA
A-1020	470252	SEAT RITMO DIESEL
A-1024	470221	LAND ROVER 88/109
A-1025	470210	LAND ROVER 1300
A-1026	470217	LAND ROVER 88 TAXI
A-1028	470256	SEAT 131 SUPERM
A-1030	473112	TALBOT 150
A-1031	471307	TALBOT 180-2L
A-1043	470262	SEAT TERRA DIESEL

CONSULTAR DISPONIBILIDAD ***

A-2006	6112	RENAULT 6
A-2019	4081	CITROEN 2CV FUR
A-2021	4369	CITROEN 2CV/DYAN
A-2022	4198	CITROEN VISA
A-2023	4362	CITROEN VISA RESER
A-2037	SUA 236	CITROEN AX
A-2046	SUA 331	SEAT IBIZA
A-2064	SUA 394	RENAULT CLIO DIESEL
A-4007	1254511	OPEL ASTRA 1,7 D
A-4008	1254512	OPEL ASTRA 1,4
A-4003	1254174	OPEL CORSA
A-4053	1109	OPEL CORSA CONEC
A-5002	21083827010	LADA SAMARA
A-5003	867919051	VW POLO 1ª
A-5004	SUA 307	NISSAN PATROL





12.0491 12V
12.0492 24V
 RELE TRABAJO CONTINUO
 CARGA MAX: 80A (12V) / 50A (24V)
 CONEXIÓN : TORNILLO X4



12.0325 12V
12.0326 24V
 RELE ARRANQUE TIPO LUCAS
 CARGA MAX: 60A (12V) / 40A (24V)
 CONEXIÓN: TORNILLO
 (FASTON AUX)
 SRB325 / 76766



12.0741 12V
12.0742 24V
 RELE TRABAJO CONTINUO
 CARGA MAX: 80A (12V) / 50A (24V)
 CONEXIÓN ; TORNILLO X6
 67-741 / 67-742



12.0670 12V
12.0671 24V
 RELE ARRANQUE
 CARGA MAX: 80A (12V) / 50A (24V)
 CONEXIÓN: TORNILLO
 TIPO REMY
 67-702 / 67-703



12.1008
 RELE ARRANQUE 24V
 CARGA : 200A
 CARGA MAX: 800A (5')
 TORNILLO M6 X2
 FASTON 6,3mm X2
 MEDIDAS; 116*45mm



12.1807
 RELE ARRANQUE 12V
 CARGA : 200A
 CARGA MAX: 800A (5')
 TORNILLO M6 X2
 FASTON 6,3mm X2
 MEDIDAS; 116*45mm



12.8068
 RELE 12V TRABAJO CONTINUO
 CARGA : 200A
 CARGA MAX: 900A (5')
 TORNILLO M6 *2 / M4 *4
 MEDIDAS; 116*45mm

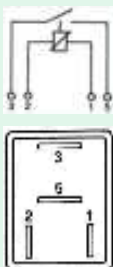

12.0363
 MICRO RELE
 VOLTAJE : 12V
 25 AMP.
 4 TERMINALES FASTON

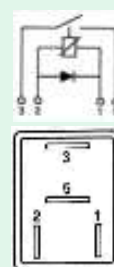

12.0364
 MICRO RELE
 VOLTAJE : 12V
 25 AMP.
 4 TERMINALES FASTON
 CON DIODO 



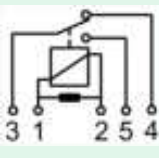
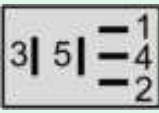

18.0216.0000
 MICRO RELE
 VOLTAJE : 12V
 15/25 AMP.
 5 TERMINALES FASTON
 CON RESISTENCIA

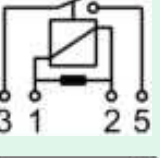
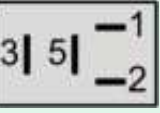
18.0295.0000
 MICRO RELE
 VOLTAJE : 12V
 25 AMP.
 4 TERMINALES FASTON
 CON RESISTENCIA

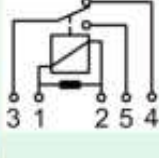
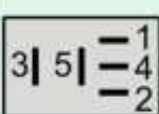

18.0218.0000
 MICRO RELE
 VOLTAJE : 24V
 10/20 AMP.
 5 TERMINALES FASTON
 CON RESISTENCIA
 EQUIPO ORIGINAL IVECO

18.0232.0000 12V 40A
18.0234.0000 24V 22A
 MINI RELE
 5 TERMINALES FASTON
 CON SOPORTE
 DOBLE SALIDA

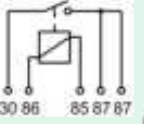
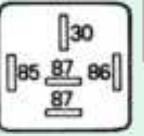
18.0242.0000 24V 22A
18.0244.0000 12V 40A
 MINI RELE
 CON DIODO
 5 TERMINALES FASTON
 C/SOPORTE
 DOBLE SALIDA

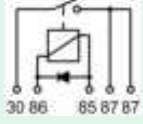
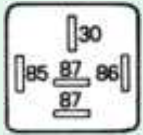

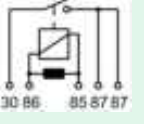
18.0258.0000 12V 40A
18.0262.0000 24V 22A
 MINI RELE
 CON RESISTENCIA
 5 TERMINALES FASTON
 CON SOPORTE
 DOBLE SALIDA

18.0246.0000 12V 40A
18.0248.0000 24V 22A
 RELE CONMUTADO
 5 TERMINALES FASTON
 C/SOPORTE

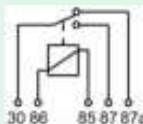
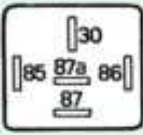

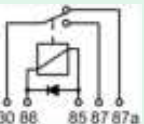
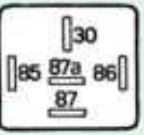
18.0250.0000 12V 40A
18.0252.0000 24V 22A
 MINI RELE
 CON DIODO
 5 TERMINALES FASTON
 CON SOPORTE

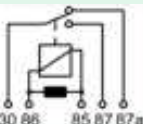
18.0260.0000 12V 40A
18.0264.0000 24V 22A
 MINIRELE CONMUTADO
 CON RESISTENCIA
 5 TERMINALES FASTON
 C/SOPORTE

18.0301.0000 12V 70A
18.0307.0000 24V 40A
 MINI RELE POTENCIA
 4 FASTON (2*9.2) + (2*6.3)
 CON SOPORTE

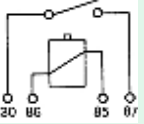
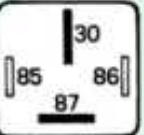
18.0227.0000 12V 200A
18.0228.0000 24V 100A
 RELE HEAVY DUTY
 2* M6 + 2 FAST. 6.3
 C/SOPORTE

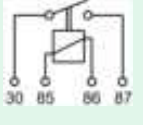
AV.18.0101 12V 30A
AV.18.0102 24V 20A
 MINI RELE CON FUSBIBLE
 LITTELFUSSE
 4 FASTON 6,3mm
 C/SOPORTE

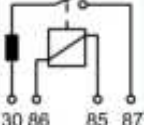
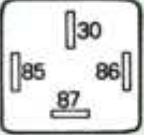

00105013
INTERMITENCIA ELECTRONICA
 12V
 4X21W + 1X3W
 19.0083.0000
 1005989

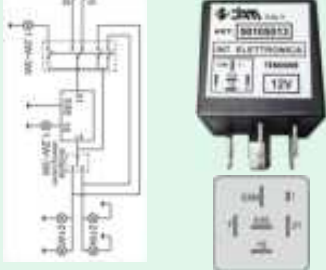

00105014
INTERMITENCIA ELECTRONICA
 24V
 4X21W + 1X3W
 1005991



19.0085.0000
INTERMITENCIA
 12V
 2(4)x21Wx0,4W
 19.0087.0000
 1027249



19.055.000 12V 47W
19.056.000 24V 47W
INTERMITENCIA
 12V 180W MAX. 1090517
 24V 220W MAX 1090913
 C/ SOPORTE



AV.19.0009
INTERMITENCIA
 12V
 2+1(6)X21W+(2)0,4W
 85 PULS. MIN.
 19.0108.0000
 1090912



AV.19.0011
INTERMITENCIA
 10-16V
 3-92W
 2+1(6)X21W+(2)0,4W
 1003729



AV.19.0019
INTERMITENCIA
 12V
 140W
 2(4)x21Wx0,3W
 1003738
ESPECIAL LED



19.1314
INTERMITENCIA
 12V
 150W MAX.
 12.8V 0.1W-150W
 C/ REGULADOR



19.0066.0000
CENTRALITA INTERMITENTES
 9-16V
TIPO ISO-NASO
CONECTOR FRAMATONE
 1058154
 19.058.000



19.0072.0000
CENTRALITA INTERMITENTES
ISO-NASO ASAE 279
CASE /STEYR / NEW HOLLAND
SUSTITUYE A: 19.057.000***
*****- PARA SUSTITUIR 19.057.000**
SE NECESITA 19.0072.0999
+19.0072.0000



19.0074.0000
INTERMITENCIA
 12V
 (2+1+1)x21+5W(8X21W)
 19.0096.0000
 1078480
 00.53.011
 19.101.000



19.0094.0000
INTERMITENCIA
 12V
 2+1+1)x21+5W(8X21W)
SUSTITUYE A:
 00.53.0016 / 19.0091.0000



0034-0351
 TEMPORIZADOR
 PRECALENTAMIENTO
 12V /80AMP
 SUSTITUYE A:
 00117067.01



0034-0421
 TEMPORIZADOR
 PRECALENTAMIENTO
 24V /80AMP



18.0133.0000
 RELE TEMPORIZADOR
 12V 5A
 TEMPORIZADOR 2 SEG.
 1027046



18.0231.0000
 RELE PASO A PASO
 12V 5A
 CIAM 01170909
 CIAM 01170720



00117092
 RELE TEMPORIZADOR
 REGULABLE
 12V
 REGULACIÓN DE 0" A 10"
 1006021



00117125
 TEMPORIZADOR ESTABLE
 12V
 TEMPORIZADOR A 10"SEG.

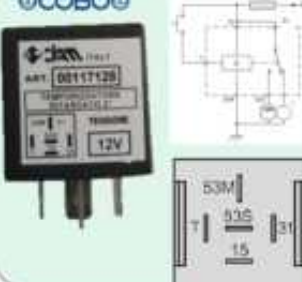

00117128
 TEMPORIZADOR RETARDO
 12V
 TEMPORIZADOR A 3"SEG.
 1004577
 SUSTI. 0034.0985



001171028
 RELE BIESTABLE SIN MEMORIA
 12V
 CARGA MX 5A
 1007927



34.009.000
 DIODO SUPRESOR
 12V 6A
 SUSTITUYE A: 34.008.000



34.14.0477401 1A
34.14.0491201 3A
 DIODO FORMATO FUSIBLE
 ENCHUFABLE-



38.0024.0000
 SENSOR DE PRESENCIA
 ASIENTOS MT-COBO
 PULSADOR OFF
 CONECTOR SEAL 3 VIAS
 1031416



38.0025.0000
 SENSOR DE PRESENCIA
 ASIENTOS MT-COBO
 PULSADOR OFF
 CONECTOR SEAL 2 VIAS
 1031418



R-0999
 CAPILLA RELOJ
 UNIVERSAL
 PARA RELOJES DE Ø52MM

20.0107.0000

CAJA CONEXIONES ESTANCA
 BASE DE GOMA
 8 VIAS
 SUSTITUYE A 24.110.000



20.0105.0000

CAJA CONEXIONES
 C/ TAPA
 PLASTICO
 10 VIAS

20.0108.0000

MULTILINK CANBUS
 MULTICONEXION PARA CANBUS
 24 VIAS
 24V



KIT CONECTOR ESPECIAL
27.0938.0000

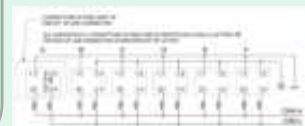

27.0948.0000

SOPORTE MODULAR RELES
 2 RELES
 KIT CON:
 2 BASES + MODULO+2 SOPOR-
 TES

27.0947.0000

CAJA MODULAR PORTAFUSI-
 BLES
 18 FUSIBLES MTA
 KIT CON:
 BASE+2 SORTES + TAPA + 36
 TERMINALES.



24.045.0000

PORTAFUSIBLES TIPO BOSCH
 2 VIAS

24.047.0000

PORTAFUSIBLES TIPO BOSCH
 6 VIAS



24.046.0000

PORTAFUSIBLES TIPO BOSCH
 4 VIAS

24.048.0000

PORTAFUSIBLES TIPO BOSCH
 8 VIAS



24.051.0000

PORTAFUSIBLES TIPO BOSCH
 12 VIAS

24.222.0000

PORTAFUSIBLES TIPO MTA
 6 VIAS MODULAR



24.200.0000

PORTAFUSIBLES TIPO
 MTA 16 VIAS / TAPA

24.223.0000

PORTAFUSIBLES TIPO MTA
 12 VIAS



39.014.0000

CONVERTIDOR CORREINTE
 ENTRADA 48/80V
 SALIDA: 24V
 PROTECCIÓN SOBRE CARGA

MAX 10A

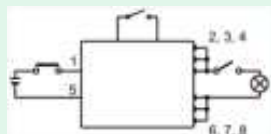



3222
 ALTERNADOR PARALELO
 12V
 10 POLOS
 2 CABLES TERM. FASTON
LOMBARDINI- DEUTZ

3236
 ALTERNADOR PARALELO
 12V 200W
 10 POLOS
 2 CABLES TERM. FASTON
AUSA-DEUTZ



3264
 ALTERNADOR CONTRAFASE
 12V 200W
 10 POLOS
 3 CABLES TERMI. FASTON
LOMBARDINI

3265
 ALTERNADOR CONTRAFASE
 12V 200W
 10 POLOS
 3 CABLES TERM. FASTON
LOMBARDINI
 ED0011571530



3325
 ALTERNADOR CONTRAFASE
 12V 250W
 10 POLOS
 3 CABLES TERM. FASTON
LOMBARDINI
 ED0011571580

3385
 ALTERNADOR CONTRAFASE
 12V 24A
 10 POLOS
 3 CABLES TERM. FASTON
LOMBARDINI-KHD
 ED0011571590



5623
 ALTERNADOR PARALELO
 12V 20A
 12 POLOS
 2 CABLES TERM. FASTON
 * SOLO BOBINA SIN ARO
DEUTZ- DITER

4491
 REGULADOR PARALELO
 12V
 LUZ CONTROL
 CONECTOR 4 TERM.+2CABLES
HATZ-AUSA
 01248123



4635
 REGULADOR TRIFASICO
 12V
 LUZ CONTROL
 CONECTOR 3+3+1
LOMBARDINI
 ED0073624090
 SUSTITUYE A: 4636

7136
 REGULADOR CONTRAFASE
 12V
 LUZ CONTROL
 CONECTOR 4+3
LOMBARDINI
 ED0073623920
 SUSTITUYE 7176



7155
 REGULADOR CONTRAFASE
 12V
 LUZ CONTROL
LOMBARDINI
 SUSTITUYE A:
 7154 / 4175 / 4176 / 4136 / 4172

7158
 REGULADOR CONTRAFASE
 24V
 LUZ CONTROL
LOMBARDINI 24V
 SUSTITUYE A: 4178 / 4185





7255

REGULADOR PARALELO
12V

LUZ CONTROL

SUSTITUYE A: 4276/ 4236/ 4272/
4262/ 4271/ 7402/ 7212/ 7222/
7232 /7271/ 4275/ 4266/ 7236

LOMBARDINI



7258

REGULADOR PARALELO
24V

LUZ CONTROL

SUSTITUYE A: 4238 / 4278

LOMBARDINI 24V

ED0073624030

ED0073623380



7435

REGULADOR PARALELO
12V

LUZ CONTROL

TOMA W

SUSTITUYE A:4435 / 4436 / 4445



6705

CONECTOR ESPECIAL
PARA REGULADORES SARPISA



A307

CUADRO CONTROL SARPISA
12V

7 TESTIGOS + LLAVE ARRANQUE
(LLAVE 470004)+CTA. HORAS

LOMBARDINI

ED0072454990



C005

CUADRO CONTROL SARPISA
12V

3 TESTIGOS + LLAVE ARRANQUE

(LLAVE 470004)+ CTA. HORAS

LOMBARDINI



H315

CUADRO CONTROL SARPISA
C/ REGULADOR 12V/24A

3 TESTIGOS + LLAVE ARRANQUE
(LLAVE 470004)+ CTA. HORAS

LOMBARDINI

ED0072454910



J109

CUADRO CONTROL SARPISA
12V

9 TESTIGOS + CTA. HORAS +
PRECALENTAMIENTO AUTOMATICO + PROTECCION MOTOR

PALFINGER

EEA5058

EE-12V



AYUDA ENCENDIDO ELECTRONICO UNIVERSAL NOSSO
PARA DELCO CON PLATINOS (NO SUSTITUYE PLATINOS)

—MAYOR DURACIÓN BUJIAS Y PLATINOS

—MEJOR RESPUESTA EN ACELERACIÓN

—MEJORA EL ARRANQUE EN FRIO

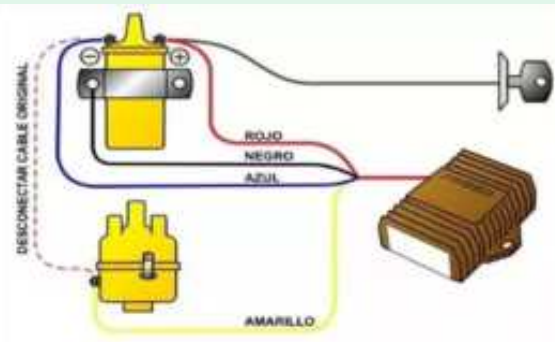

**11.0SPB**

TENSIÓN: 12/24V.
 USO CONTINUO: 250 A
 CARGA MÁXIMA: > 2500 A: (5")
 TEMP. USO : -40° / + 80°
 NORMA: ISO 8846
 MANETA FIJA - BLINDADO
 CONTACTOS CU.

**11.0SPL**

TENSIÓN: 12/24V.
 USO CONTINUO: 250 A
 CARGA MÁXIMA: > 2500 A: (5")
 TEMP. USO : -40° / + 80°
 NORMA: ISO 8846
 LLAVE EXTRAIBLE - BLINDADO
 CONTACTOS CU.

**11.0SXB**

TENSIÓN: 12/24 V.
 USO CONTINUO: >400 A
 CARGA MÁXIMA: > 4000 A: (5")
 TEMP. USO : -40° / + 80°
 NORMA: ISO 8846
 MANETA FIJA - BLINDADO
 CONTACTOS CU.

**11.0SXL**

TENSIÓN: 12/24 V.
 USO CONTINUO: >400 A
 CARGA MÁXIMA: > 4000 A: (5")
 TEMP. USO : -40° / + 80°
 NORMA: ISO 8846
 LLAVE EXTRAIBLE - BLINDADO
 CONTACTOS CU.

**11.SXBA**

TENSIÓN: 12/24 V.
 USO CONTINUO: >400 A
 CARGA MÁXIMA: > 4000 A: (5")
 TEMP. USO : -40° / + 80°
 NORMA: ISO 8846
 MANETA FIJA - BLINDADO
 CONTACTO AUX.ILIARES

**11.SXLA**

TENSIÓN: 12/24 V.
 USO CONTINUO: >400 A
 CARGA MÁXIMA: > 4000 A: (5")
 TEMP. USO : -40° / + 80°
 NORMA: ISO 8846
 LLAVE EXTRAIBLE - BLINDADO
 CONTACTO AUX.ILIARES

**11.0SCL**

TENSIÓN: 12/24V.
 USO CONTINUO: >100 A
 CARGA MÁXIMA: > 500 A: (5")
 TEMP. USO : -40° / + 80°
 NORMA: USO NAÚTICO
 LLAVE EXTRAIBLE PVC

11.MSCL

LLAVE PARA DESCONECTADOR
 11.0SCL

**11.MSML**

LLAVE PARA DESCONECTADOR
 11.0SPL

**08.0103**

TENSIÓN: 12/24 V.
 USO CONTINUO: 250 A
 CARGA MÁXIMA: 2500 A: (5")
 TEMP. USO : -40° / + 80°
 NORMA: IP65
 MANETA EXTRAIBLE -
 4 BORNES—CONTACTOS CU.

08.0801

TENSIÓN: 12/24V.
 USO CONTINUO: 150 A
 CARGA MÁXIMA: 1200 A: (5")
 TEMPERATURA USO : -40° / + 80°
 NORMA: IP65
 BOTON FIJO—CONEXIÓN GIRO
 CONT AUXILIAR

**(USO NAÚTICO) 08.0807**

TENSIÓN: > 12/24V.
 USO CONTINUO: 300 A
 CARGA MÁXIMA: 1000 A: (5")
 TEMPERATURA USO : -40° / + 80°
 NORMA: IP54
 ROTANTE ON - OFF

08.0809 (USO NAÚTICO)

TENSIÓN: > 12/24V.
 USO CONTINUO: 300 A
 CARGA MÁXIMA: 1000 A: (5")
 TEMPERATURA USO : -40° / + 80°
 NORMA: IP54
 ROTANTE OFF / 1 / 2 / 1+2
 SELECCIONADOR BATERÍA



**08.0840**

TENSIÓN: 12/24 V.
 USO CONTINUO: 250 A
 CARGA MÁXIMA: 1000 A: (10")
 TEMPERATURA USO : -40° / + 80°
 NORMA: IP65/IP69K
 MANETA FIJA - 4 BORNES (+/-)
 CONTACTOS CU./AG

08.0983

TENSIÓN: > 12/24V.
 USO CONTINUO: 250/350 A
 CARGA MÁXIMA: > 2500 A: (3")
 TEMPERATURA USO : -40° / + 80°
 NORMA: IP65
 LLAVE EXTRAIBLE
 CONTACTOS CU.AG.

**08.0984**

TENSIÓN: > 12/24V.
 USO CONTINUO: 250/350 A
 CARGA MÁXIMA: > 2500 A: (3")
 TEMPERATURA USO : -40° / + 80°
 NORMA: IP65
 LLAVE PUSH - CONTACTOS
 CU.AG.

08.0987 USE =08.0990

TENSIÓN: 12/24V.
 USO CONTINUO: 100 A
 CARGA MÁXIMA: 500 A: (5")
 TEMPERATURA USO : -40° / + 80°
 NORMA: IP43
 LLAVE EXTRAIBLE
 CONTACTOS CU.

**08.0990**

TENSIÓN: > 12/24V.
 USO CONTINUO: 150 A
 CARGA MÁXIMA: > 500A: (3")
 TEMPERATURA USO : -40° / + 80°
 NORMA: IP65
 LLAVE EXTRAIBLE
 CONTACTOS CU

08.0991 (IVECO)

TENSIÓN: > 12/24V.
 USO CONTINUO: 250/350 A
 CARGA MÁXIMA: > 2500 A: (3")
 TEMPERATURA USO : -40° / + 80°
 NORMA: IP65
 LLAVE FIJA
 CONTACTOS CU.AG.

**(IVECO) 08.0995ECO**

TENSIÓN: > 12/24V.
 USO CONTINUO: 250/350 A
 CARGA MÁXIMA: > 2500 A: (5")
 TEMPERATURA USO : -40° / + 80°
 NORMA: IP65
 LLAVE FIJA - CONTACTOS CU.AG.
 CONTACTO AUXILIAR

08.1240

TENSIÓN: 12/24V.
 USO CONTINUO: 100 A
 CARGA MÁXIMA: 500 A: (5")
 TEMPERATURA USO : -40° / + 80°
 NORMA: IP43
 LLAVE EXTRAIBLE
 CONTACTOS CU.

**08.1241**

TENSIÓN: 12/24 V.
 USO CONTINUO: 200 A
 CARGA MÁXIMA: 2000 A: (5")
 MANETA FIJA
 CONTACTOS CU.
 4 BORNES + / -

08.1242

TENSIÓN: 12/24 V.
 USO CONTINUO: 250 A
 CARGA MÁXIMA: 2500 A: (5")
 TEMPERATURA USO : -40° / + 80°
 MANETA FIJA
 CONTACTOS CU.
 R.V.I. SIN CONTACTOS AUX.

**08.1243**

TENSIÓN: 12/24 V.
 USO CONTINUO: 250 A
 CARGA MÁXIMA: 2500 A: (5")
 TEMPERATURA USO : -40° / + 80°
 MANETA FIJA
 CONTACTOS CU.
 R.V.I. CON CONTACTOS AUX.

11.0001 GRANDE

TENSIÓN: 12/24V.
 USO CONTINUO: 150 A
 Ø FIJACIÓN 22 mmP OMO ROSCADO

11.0002 PEQUEÑO

TENSIÓN: 12/24V.
 USO CONTINUO: 150 A
 Ø FIJACIÓN 14 mm



**11.0003**

TENSIÓN: 12/24 V.
 USO CONTINUO: 100 A
 CARGA MÁXIMA: 1000 A: (5")
 TEMP. USO : -40° / + 80°
 Ø BORNE NEGATIVO BATERÍA
 CONTACTO CU.
 POMO VERDE / AZUL

11.0004

TENSIÓN: 6 / 12V.
 USO CONTINUO: 85 A
 CARGA MÁXIMA: 100 A: (5")
 TEMP. USO : -30° / + 50°
 Ø BORNE NEGATIVO BATERÍA
 COBRE / ZINC
 POMO PVC AZUL

**11.0101**

TENSIÓN: 12/24 V.
 USO CONTINUO: 200 A
 CARGA MÁXIMA: 1000 A: (5")
 TEMPERATURA USO : -40° / + 85°
 LLAVE EXTRAIBLE
 CONTACTOS CU.-
MAN 81.25506.6033

11.0105

TENSIÓN: 12/24V.
 USO CONTINUO: 100 A
 CARGA MÁXIMA: 500 A: (5")
 TEMP. USO : -40° / + 80°
 NORMA: IP43
 LLAVE EXTRAIBLE
 CONTACTOS CU.

**11.0988**

TENSIÓN: 12/24V.
 USO CONTINUO: >250 /350A
 CARGA MÁXIMA: > 2500 A: (3")
 TEMPERATURA USO : -40° / + 80°
 NORMA: IP65
 LLAVE EXTRAIBLE
 CONTACTOS CU./AG.

08.0988

TENSIÓN: 12/24V.
 USO CONTINUO: 250A
 CARGA MÁXIMA: 2200 A: (3")
 TEMPERATURA USO : -40° / + 80°
 NORMA: IP65
 LLAVE EXTRAIBLE
 CONTACTOS CU.
 SIN ACCESORIOS

**11.1101**

TENSIÓN: 12/24V.
 USO CONTINUO: 100 A
 CARGA MÁXIMA: 500 A: (5")
 TEMP. USO : -40° / + 80°
 NORMA: IP43
 CONTACTOS CU.
RELOS 500018

11.1339

TENSIÓN: 12/24 V.
 USO CONTINUO: 150 A
 CARGA MÁXIMA: 1200 A: (5")
 TEMP. USO : -40° / + 80°
 LLAVE FIJA - CONEXIÓN GIRO
 CONTACTOS CU.- CONT. AUX.
VOLVO 21243844 / 21199003

**11.1340**

TENSIÓN: 12/24 V.
 USO CONTINUO: 200 A
 CARGA MÁXIMA: 1000 A: (5")
 TEMPERATURA USO : -40° / + 85°
 LLAVE FIJA 360
 COMPATIBLE CORMAR 1101
 CONTACTOS CU.-

SP-12/24

CONMUTADOR
 SERIE PARALELO
 12V / 24V

**08.0264 (12V) 08.0265 (24V)**

DESCONECTADOR C/MANDO
 USO CONTINUO: 180A
 CARGA MÁXIMA: 1000 A: (3")
 TEMP USO : -40° / + 80°
 NORMA: IP54
 CON MANDO DISTANCIA
 CONSUMO MANDO: 0,0085A

SP-12/24-300

CONMUTADOR SERIE PARALELO
 CARGA CONTINUO 300A
 CARGA MAX. 1000A
 TEMP- USO -40° / +80°
FENDT F816900020030





08.0266 (12V)

KIT DESCONECTADOR C/MANDO
USO CONTINUO: 180A
CARGA MÁXIMA: 1000 A: (3")
TEMP USO : -40° / + 80°
KIT DE INSTALACIÓN DIREC.BAT.
CON MANDO DISTANCIA
CONSUMO MANDO: 0,0085A



08.0267 (24V)

KIT DESCONECTADOR C/MANDO
USO CONTINUO: 180A
CARGA MÁXIMA: 1000 A: (3")
TEMP USO : -40° / + 80°
KIT DE INSTALACIÓN DIREC.BAT.
CON MANDO DISTANCIA
CONSUMO MANDO: 0,0085A



08.0949

TENSIÓN: 12V
USO CONTINUO: 250 A
CARGA MÁXIMA: 2500 A: (3")
TEMPERATURA USO : -40° / + 80°
DESCONEXIÓN + Ó -
PROTECCIÓN IP65
BOBINA AISLADA



08.0948

TENSIÓN: 24V
USO CONTINUO: 250 A
CARGA MÁXIMA: 2500 A: (3")
TEMPERATURA USO : -40° / + 80°
DESCONEXIÓN + Ó -
PROTECCIÓN IP65
BOBINA AISLADA

08.0966

TENSIÓN: 24V
USO CONTINUO: 250 A
CARGA MÁXIMA: 2500 A: (3")
TEMPERATURA USO : -40° / + 80°
DESCONEXIÓN + Ó -
PROTECCIÓN IP65
BOBINA AISLADA



08.0753

TENSIÓN: 10/32V.
USO CONTINUO: 250 A
CARGA MÁXIMA: 2000A: (3")
TEMPERATURA USO : -40° / + 80°
DESCONEXIÓN + BIESTABLE
PROTECCIÓN IP67 / IP69K
KIT COMPLETO



ESCANEA PARA PODER VER
EL ESQUEMA DE CONEXIÓN



00.2270

INTERRUPTOR SEGURIDAD
EXTERIOR ADR (08.0705)

00.2268

KIT CONECTOR PARA 00.2270

00.9005

TAPA PROTECTOR SEGURIDAD
INTERRUPTORES ADR

08.0955

KIT (X2) PIPETAS GOMA DESCO-
NECTADORES ADR





08.0985

TENSIÓN: 12/24 V.
USO CONTINUO: 350 A
CARGA MÁXIMA: 2500A: (5")
TEMP. USO : -40° / + 80°
Ø M12
MANETA EXTRAIBLE
IVECO

08.0996

TENSIÓN: 12V / 24V
USO CONTINUO: 100 A
CARGA MÁXIMA: 500 A: (5")
TEMP. USO : -30° / + 50°
Ø 6MM BORNE 5.5x4.35x4.8cm
CONTACTOS CU
ANTES 08.0100



11.0019

TENSIÓN: 12/24 V.
USO CONTINUO: 200 A
CARGA MÁXIMA: 2000 A: (5")
TEMPERATURA USO : -40° / + 85°
LLAVE EXTRAIBLE
CONTACTOS COBRE M10

11.0037

TENSIÓN: 12/24V.
USO CONTINUO: 300 A
CARGA MÁXIMA: 2500 A: (5")
TEMP. USO : -40° / + 80°
NORMA: IP43
CONTACTOS COBRE M12+M5
TOMA AUX



11.0049

TENSIÓN: 12/24V.
USO CONTINUO: >150
CARGA MÁXIMA: > 1000 A: (3")
TEMPERATURA USO : -40° / + 80°
NORMA: IP65
PULSADOR PARA DESCONECTAR
CONTACTOS CU./AG.



11.0804

TENSIÓN: 12/24V.
USO CONTINUO: 200 A
CARGA MÁXIMA: 1000A: (5")
TEMP. USO : -40° / + 80°
CONTACTOS CU. M8
MANETA FIJA

11.0099

TENSIÓN: 6/32 V.
USO CONTINUO: 300 A
CARGA MÁXIMA: 1500 A: (5")
TEMP. USO : -40° / + 80°
LLAVE FIJA - CONEXIÓN GIRO
CONTACTOS CU.-M10



08.0720

TENSIÓN: 12/24 V.
USO CONTINUO: 600 A
CARGA MÁXIMA: 3500 A: (5")
TEMPERATURA USO : -40° / + 85°
LLAVE FIJA - CONEX GIRO
HEAVY DUTY 100m*100m*85mm
CONTACTOS CU.-

08.0723

TENSIÓN: > 12/24V.
USO CONTINUO: 600 A
CARGA MÁXIMA: 3500 A: (5")
TEMPERATURA USO : -40° / + 80°
ROTANTE OFF / 1 / 2 / 1+2
HEAVY DUTY 100m*100m*85mm
SELECCIONADOR BATERÍA



08.1244

TENSIÓN: 12/24 V.
USO CONTINUO: 250 A
CARGA MÁXIMA: 2500 A: (5")
TEMPERATURA USO : -40° / + 80°
MANETA FIJA
CONTACTOS CU. M10 X 4
4 BORNES

08.ZH48

TENSIÓN: > 12/48V
USO CONTINUO: 500 A
CARGA MÁXIMA: 3000 A: (5")
TEMPERATURA USO : -40° / + 80°
IP69K M12*25mm 4 BORNES
C/ PASADOR CANDADO
* CANDADO NO INCLUIDO





05.0981.0000- DRC 1013534
05.0982.0000- IZQ 1013530



LAMPARAS (H4) 12V INCLUIDAS
 CONEXIÓN DEUTSCH 27.0862.0000
 ESTANQUEIDAD IP66
 FIJACIÓN POSTERIOR

E **COBO**



05.580.000- DRC 1015695
05.584.000- IZQ 1013714



LAMPARAS (H4) 12V INCLUIDAS
 CONEXIÓN DEUTSCH 27.0862.0000
 ESTANQUEIDAD IP66
 FIJACIÓN POSTERIOR O
 INFERIOR

E **COBO**



05.479.000- DRC 1014261
05.483.000- IZQ 1014265



LAMPARAS (H4) 12V INCLUIDAS
 CONEXIÓN POR CABLE
 ESTANQUEIDAD IP54
 FIJACIÓN INFERIOR

E **COBO**



05.1023.0000- D/I 1013623



LAMPARAS (H4) 12V INCLUIDAS
 CONEXIÓN POR CABLE
 ESTANQUEIDAD IP54
 FIJACIÓN POSTERIOR

05.439.110-OPTICA
03.300.002-TULIPA AMBAR

E **COBO**



05.1660.0000.13- DRC 1014522
05.1661.0000.13- IZQ 1014521



LAMPARAS (H5) 12V INCLUIDAS
 CONEXIÓN POR CONECTOR
 27.1660.0000
 ESTANQUEIDAD IP54
 FIJACIÓN INFERIOR

E **COBO**



05.1217.0000- DRC 1081110
05.1218.0000- IZQ 1081114



LAMPARAS (H4) 12V INCLUIDAS
 CONECTOR DEUTSCH 27.0862.0000
 ESTANQUEIDAD IP66
 FIJACIÓN INFERIOR

E **COBO**



05.0914.0000- DRC 1013415
05.0915.0000- IZQ 1013420



LAMPARAS (H4) 12V INCLUIDAS
 CONECTOR DEUTSCH 27.0862.0000
 ESTANQUEIDAD IP66
 FIJACIÓN POSTERIOR

E **COBO**



05.0894.0000- DRC 1013376
05.0895.0000- IZQ 1013386



LAMPARAS (H4) 12V INCLUIDA
 CONECTOR DEUTSCH 27.0862.0000
 ESTANQUEIDAD IP66
 FIJACIÓN INFERIOR

E **COBO**



05.0922.0000- DRC 1013448
05.0923.0000- IZQ 1013450



LAMPARAS (H4) 12V INCLUIDAS
 CONECTOR DEUTSCH 27.0862.0000
 ESTANQUEIDAD IP66
 FIJACIÓN POSTERIOR

E **COBO**



05.0918.0000.13- DRC 1013431
05.0919.0000.13- IZQ 1013432



LAMPARAS (H4) 12V INCLUIDAS
 CONECTOR DEUTSCH 27.0862.0000
 ESTANQUEIDAD IP66
 FIJACIÓN INFERIOR

E **COBO**



05.487.000- D/I 1015459



LAMPARA (H4)
 CONEXIÓN POR CABLE
 ESTANQUEIDAD IP54
 FIJACIÓN INFERIOR

E **COBO**



05.522.000- D/I 1015459



LAMPARA (H4)
 CONEXIÓN POR CABLE
 MONTAJE EMPOTRADO

E **COBO**



05.526.000- D/I 1015459



LAMPARA (H4)
CONEXIÓN CABLE
ESTANQUEIDAD IP54
FIJACIÓN INFERIOR



05.1392.0000.41 

05.1394.0000.41 

ZETOR
GRUPO OPTICO HB3
LAMPARAS INCLUIDAS (12V)
CONEXIÓN 27.0945.0000
ESTANQUEIDAD IP66





05.100.000

LAMPARA S2
CONEXIÓN FASTON 6,3
FIJACIÓN TORNILLOS
C/CERQUILLO INCLINADO 8°
REC.CRISTAL 05.100.102



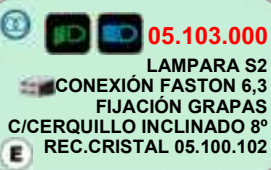

05.103.000

LAMPARA S2
CONEXIÓN FASTON 6,3
FIJACIÓN GRAPAS
C/CERQUILLO INCLINADO 8°
REC.CRISTAL 05.100.102





05.160.000 

LAMPARA FEU R2 + T4W
CONEXIÓN FASTON 6,3
FIJACIÓN GRAPA
REC.CRISTAL 05.160.112
REC.CERQUILLO 05.160.111

05.161.000 

LAMPARA FEU R2
CONEXIÓN CABLE
FIJACIÓN GRAPAS
REC.CRISTAL 05.160.112
REC. CERQUILLO 05.160.111

05.180.000

LAMPARA FEU R2 + T4W
CONEXIÓN FASTON 6,3
FIJACIÓN TORNILLO
REC.CRISTAL 05.160.112
REC.CERQUILLO 05.160.111



05.181.000

LAMPARA FEU R2
CONEXIÓN CABLE
FIJACIÓN TORNILLO
REC.CRISTAL 05.160.112
REC. CERQUILLO 05.160.111





05.311.000 

OPTICA H4
D./I. (AMBAS MANOS)

COBO

FIAT-AMA 

05.324.000

OPTICA RECAMBIO
LAMPARA FEU H4
D./I. (AMBAS MANOS)
SAME-DEUTZ



05.344.000 

OPTICA RECAMBIO
LAMPARA H4
D./I. (AMBAS MANOS)
CNH



AVST.02020 



OPTICA RECAMBIO
LAMPARA H4
D./I. (AMBAS MANOS)
1693943M93

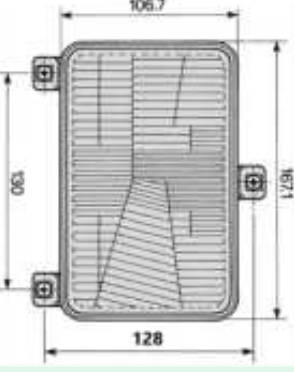





05.376.000

OPTICA RECAMBIO
LAMPARA H4
D./I. (AMBAS MANOS)
CNH

05.396.000 

OPTICA FEU R2
D./I.

AVST.01053      05.400.000

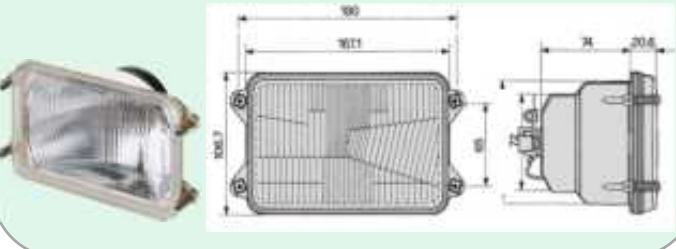
OPTICA H4
D./I. (AMBAS MANOS) JOHN DEERE RE56964 D./I. (AMBAS MANOS)

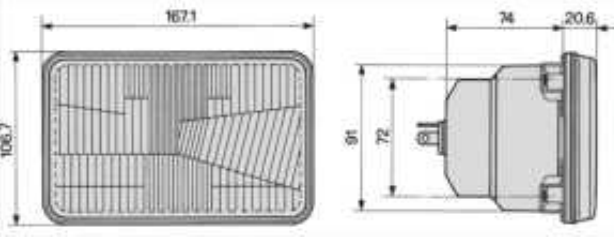

05.400.003

GRAPA (3)

05.400.200

GRUPO REGULADOR (2)

AL78501

05.400.300

REGULADOR OPTICA (1)

AL78502





 FORD-FIAT

  05.406.000

OPTICA H4
D./I. (AMBAS MANOS)

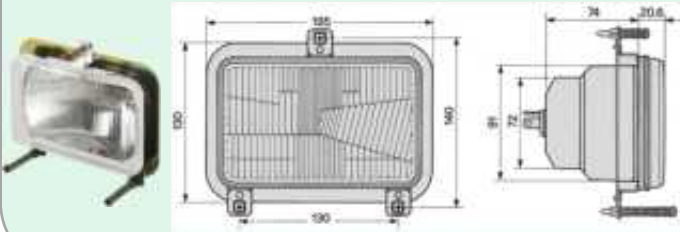

05.464.000   

OPTICA H4
D./I. (AMBAS MANOS)



CNH



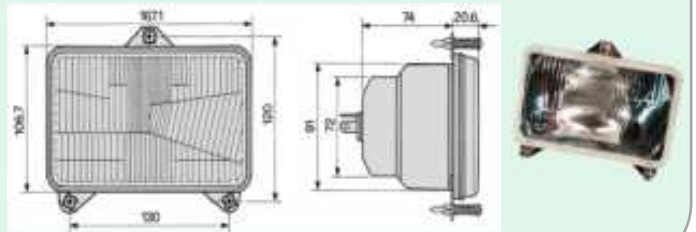



 FENDT-ZETOR-JOHN DEERE

  05.508.000

OPTICA H4
D./I. (AMBAS MANOS)

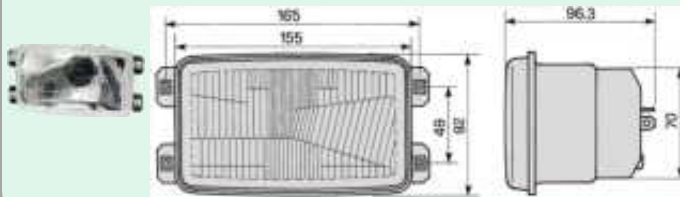

05.575.000.13   

OPTICA H4 (INLCUIDA 12V)
D./I. (AMBAS MANOS)

 AVST.02021

OPTICA H4 D./I.
(AMBAS MANOS)



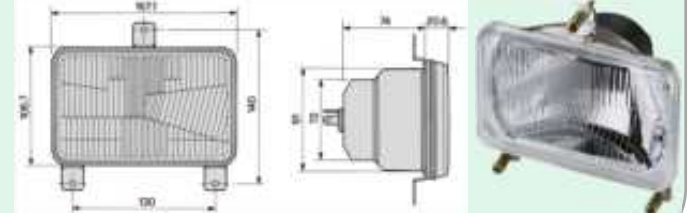



 SAME-DEUTZ-LAMBORGHINI

  05.630.000

OPTICA H4+W3W
D./I. (AMBAS MANOS)

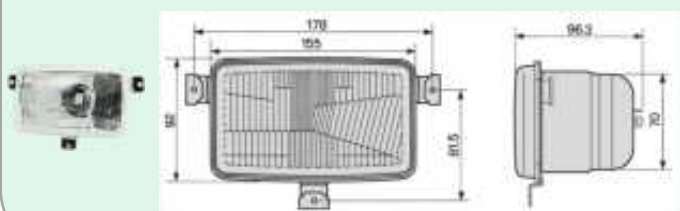

05.0780.0000.13  

OPTICA H4 (INLCUIDA 12V)
D./I. (AMBAS MANOS)



DEUTZ 2.8039.240.0



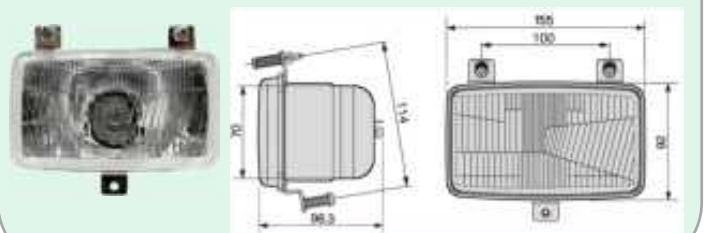





 AGCO 3824712M92

  05.0795.0000

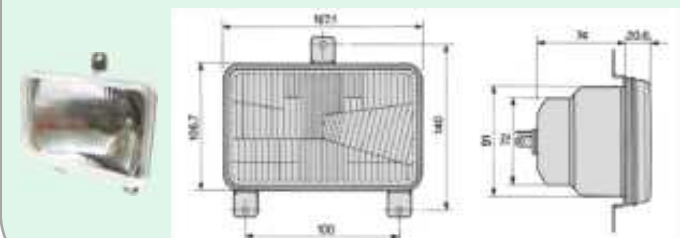
OPTICA H4
D./I. (AMBAS MANOS)



05.0833.0000  

OPTICA H4
D./I. (AMBAS MANOS)



DEUTZ 2.8039.230.0



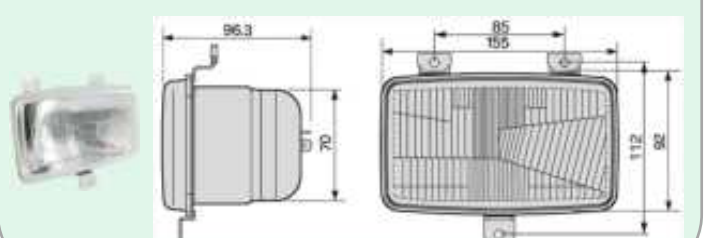

AVST.60001
OPTICA RECAMBIO LAMPARA FEU R2
DERFF



FIAT SAME DEUTZ LAMBORGHINI

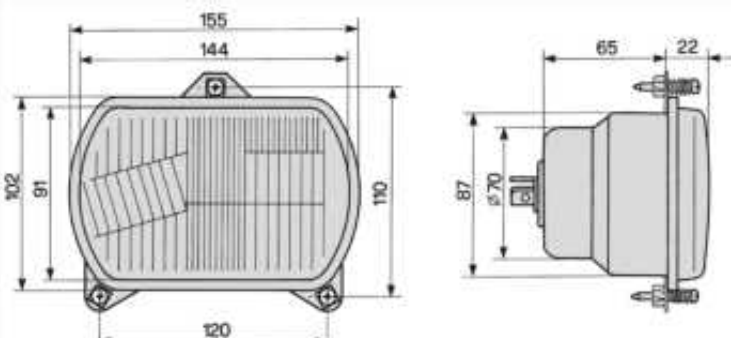

05.389.000
OPTICA RECAMBIO LAMPARA FEU R2

05.411.000
OPTICA RECAMBIO LAMPARA FEU R2+T4W

05.420.000
OPTICA RECAMBIO LAMPARA H4

05.421.000
OPTICA RECAMBIO LAMPARA H4+T4W

COBO
LANDINI-SAME

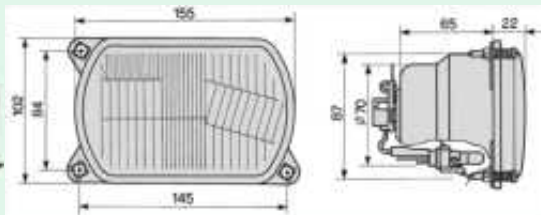

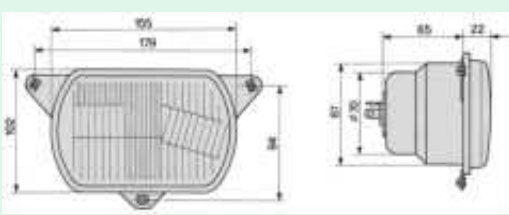

05.395.000
OPTICA FEU R2 D./I. (AMBAS MANOS)

05.455.000
OPTICA RECAMBIO LAMPARA FEU R2



05.456.000
OPTICA RECAMBIO LAMPARA FEU R2+T4W



SABA

COBO
CNH



05.0813.0000
OPTICA FEU R2 D./I. (AMBAS MANOS)

05.432.000
OPTICA FEU R2 D./I. (AMBAS MANOS)

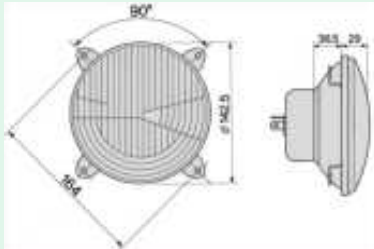

COBO



05.685.000
OPTICA RECAMBIO LAMPARA H4

05.1209.0000
OPTICA RECAMBIO LAMPARA H4+T4W



05.0820.0000
OPTICA H4 D./I.



COBO



COBO
05.0995.1000
RECAMBIO OPTICA RALLADA PARA FAROS COBO:
05.0918.0000-05.0919.0000 / 05.0914.0000-05.0915.0000
05.0894.0000-05.0895.0000 / 05.0922.0000-05.0923.0000



05.0761.0000 (D)
05.0762.0000 (IZ)
OPTICA RECAMBIO LAMPARA H4 D./I. (AMBAS MANOS)

AVST.60002 (D)
AVST.60002 (IZ)
OPTICA RECAMBIO LAMPARA H4 D./I. (AMBAS MANOS)
5089987 / 5089988

DERFF





COBO
05.1042.1000
RECAMBIO OPTICA LISA PARA FAROS COBO:
05.0918.0000-05.0919.0000 / 05.0914.0000-05.0915.0000
05.0894.0000-05.0895.0000 / 05.0922.0000-05.0923.0000



AVST.00054 CONJUNTO FAROS

NEW HOLLAND TD5010, TD5020, TD5030, TD5040, TD5050, TD55D, TD60D, TD60D PLUS, TD65D, TD70D, TD70D PLUS, TD75D, TD80D, TD80D PLUS, TD85D, TD90D, TD95D, TD95D HC PLUS, TD95D PLUS



AVST.60002D
05.0761.0000
ÓPTICA REC. DRCH
AVST.60002I
05.0762.0000
ÓPTICA REC. IZQ
AVST.00052 *
FRONTAL SIN OPTICAS
* SOLO BAJO PEDIDO.

AVST.01532 CONJUNTO FAROS

JOHN DEERE 6230, 6330, 6430, 6530, 6534, 6630, 6830, 6930, 7130, 7230, 7330, 7430, 7530



AVST.01045R
ÓPTICA REC. DRCH / IZQ
AL178138
AVST.01046 *
FRONTAL SIN OPTICAS
* SOLO BAJO PEDIDO.
AL181666

AVST.01050D (DRC) / AVST.01050 I (IZQ)

JOHN DEERE 350, 1550, 1750, 1850, 1950, 2250, 2450, 2650, 2850, 3050, 3350, 1030, 1130, 1630, 1830, 2030, 2130, 3030, 3130, 1040, 1140, 1640, 1840, 2040, 2140, 3040, 3140, 3640



AVST.02019
ÓPTICA REC. DRCH
ÓPTICA REC. IZQ
AVST.01051G
CERQUILLO NEGRO
*SOLO BAJO PEDIDO
AVST.01051D*
AVST.01051I*
CUERPO SIN OPTICAS
* SOLO BAJO PEDIDO.

AVST.02050E * CONJUNTO FAROS

MASSEY FERGUSON 350, 352, 355, 360, 362, 365, 372, 375, 382, 390, 396, 398, 399
BAJO PEDIDO*



AVST.02020
05.344.000
ÓPTICA REC. DRCH / IZQ
AVST.02050 *
FRONTAL SIN OPTICAS
* SOLO BAJO PEDIDO.

AVST.02017D (DR) AVST.02017I (IZ) *

FARO MASSEY FERGUSON 135, 148, 165, 168, 175, 178, 185, 188
BAJO PEDIDO*



AVST.02018D
ÓPTICA REC. DRCH
AVST.02018I
ÓPTICA REC. IZQ
AVST.02016D *
AVST.02016I*
CUERPO SIN OPTICAS
* SOLO BAJO PEDIDO.

AVST.00022  

OPTICA FIAT NEW HOLLAND
5120073, 9959903, 5138349, 5122379, 5122382,
5141169, 79060364, 9959888, 9961845

E



AVST.00022  

OPTICA FIAT NEW HOLLAND
51632902, 47794168, 170026770



AVST.01060  

OPTICA JOHN DEERE SERIE 6000
AL152328, AL152330, 25/181-215

E



AVST.01033  

OPTICA JOHN DEERE SERIE 5000
RE269110

E



AVST.02019  

OPTICA MASSEY FERGUSON 1672768M91
JOHN DEERE DE12298

E



AVST.02018D / AVST.02018I  

ÓPTICA MASSEY FERGUSON 1672766M91 (D)
1672767M91 (IZ)

E





AVST.00097D (RH)
REF. OE 84156844
AVST.00097I (LH)
REF. OE 84156845

**FARO PRINCIPAL
NEW HOLLAND**
TSA TS110A Delta , TS100A Delta
TLA TL90A , TL80A , TL70A , TL100A
TVT TVT170 , TVT190 , TVT155 , TVT145 ,
TVT135 , TVT195
T5000 T5040 , T5050 , T5060
T7500 T7550 , T
7540 , T7510 , T7520 , T7530
T6000 T6010 Delta
T6020 Delta , T6020 Plus , T6010



AVST.00099D (RH)
REF. OE 87693642
AVST.00099I (LH)
REF. OE 87693644

**FARO PRINCIPAL
NEW HOLLAND**
T5000T 4.105 T 4.115
T 4.55 POWERSTAR T 4.65 POWERSTAR
T 4.75 POWERSTAR T 4.85 T 4.95 T 4020
T 4030 T 4030 Deluxe T 4040 T 4040
Deluxe T 4050 T 4050 Deluxe T 5.105 T
5.105 Electro Command T 5.115 T 5.115
Electro Command T 5.95 T 5.95 Electro
Command



AV.05.0070
FARO PRINCIPAL FULL LED 10-48V
FIJACIÓN POSTERIOR—CONEXIÓN CABLE



05.2160.0000
FARO PRINCIPAL FULL LED 9/32V
D./I. C/ CONECTOR DEUTSCH
***BAJO PEDIDO**



05.2082.0000.13
05.2083.0000.13
FARO HIBRIDO H4 12V + LED
C/ CONECTOR DEUTSCH

05.2082.0000.42
05.2083.0000.42
FARO HIBRIDO H4 24V + LED
C/ CONECTOR DEUTSCH



05.2091.0000.13
05.2092.0000.13
FARO HIBRIDO H4 12V + LED
C/ CONECTOR DEUTSCH

05.2091.0000.42
05.2092.0000.42
FARO HIBRIDO H4 24V + LED
C/ CONECTOR DEUTSCH



05.2084.0000
05.2085.0000
FARO FULL LED 9/32V
C/ CONECTOR DEUTSCH
***BAJO PEDIDO**

05.2120.0000
05.2121.0000
FARO FULL LED 9/32V
C/ CONECTOR DEUTSCH
***BAJO PEDIDO**

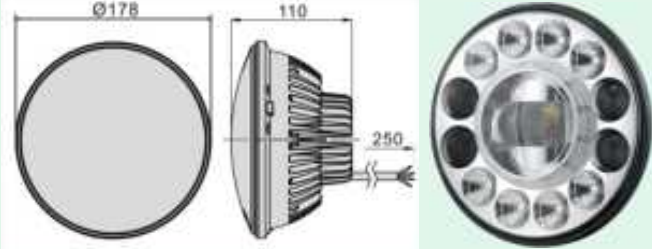
AV.05.0045
***BAJO PEDIDO OPTICA FULL LED 7"**
9-32V D./I. (AMBAS MANOS) R10-R112-R7



AV.05.0071
FARO FULL LED *BAJO PEDIDO
D./I. (AMBAS MANOS) R10-R112-R87-R7 9-32V



AVPH.05111
 FARO FULL LED
 9-32V
 FIJACIÓN;
 INFERIOR O POSTERIOR
 (SE INTERCAMBIA EL SOPORTE)
 CONECTOR DEUTSCH INCLUIDO
 228*151*106mm
 -ECE R112
 -ECE R87



AVPH.05117
 FARO FULL LED
 9-32V
 FUNCIÓN ANTIHIELO
 FIJACIÓN;
 INFERIOR O POSTERIOR
 (SE INTERCAMBIA EL SOPORTE)
 CONECTOR DEUTSCH INCLUIDO
 215*150*85mm
 -ECE R112
 -ECE R6
 -ECE R87



AVPH.05113
 FARO FULL LED
 9-32V 3600Lm
 FUNCIÓN ANTIHIELO
 FIJACIÓN;
 INFERIOR O POSTERIOR
 (SE INTERCAMBIA EL SOPORTE)
 CONECTOR DEUTSCH INCLUIDO
 340*85*107mm
 -ECE R112
 -ECE R6
 -ECE R7



AVFF.05437
 FARO FULL LED
 9-32V
 FUNCIÓN ANTIHIELO
 FIJACIÓN;
 INFERIOR O POSTERIOR
 (SE INTERCAMBIA EL SOPORTE)
 CONECTOR DEUTSCH INCLUIDO
 -ECE R10
 -ECE R148
 -ECE R149



AVFF.05438
 FARO FULL LED
 9-32V 3600Lm
 FUNCIÓN ANTIHIELO
 FIJACIÓN;
 INFERIOR O POSTERIOR
 (SE INTERCAMBIA EL SOPORTE)
 CONECTOR DEUTSCH INCLUIDO
 -ECE R10
 -ECE R148
 -ECE R149
 CON ANTINEBLA

AVST.00071

PILOTO DELANTERO NEW HOLLAND / FIAT
 REF. OE 84262863
 REF. RECAMBIO TULIPA: AVST.00071T
 DERECHO / IZQUIERDO
 CALIDAD ALTERNATIVA
CON SOPORTE PARA TUBO

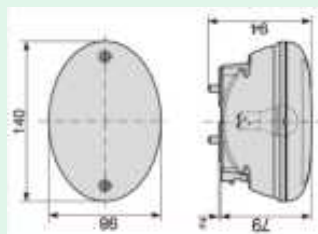

AVST.00075

PILOTO DELANTERO NEW HOLLAND / FIAT
 REF. OE 5099643A
 REF. RECAMBIO TULIPA: AVST.00071T
 DERECHO / IZQUIERDO
 CALIDAD ALTERNATIVA
SUJECIÓN LATERAL

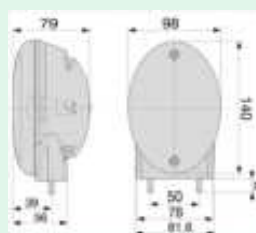

AVST.00033

PILOTO DELANTERO NEW HOLLAND / FIAT
 REF. OE 5099643
 REF. RECAMBIO TULIPA: AVST.00071T
 DERECHO / IZQUIERDO
 CALIDAD ALTERNATIVA
SUJECIÓN LATERAL SOPORTE TUBO

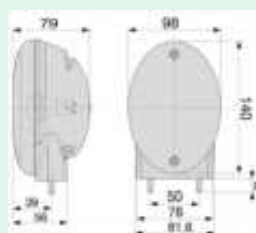

AVST.00078

PILOTO DELANTERO NEW HOLLAND / FIAT
 REF. UNIVERSAL
 REF. RECAMBIO TULIPA: AVST.00071T
 DERECHO / IZQUIERDO
 CALIDAD ALTERNATIVA
MONTAJE SUPERFICIE M5

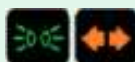
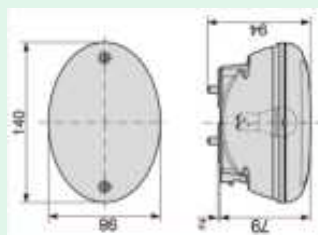



(DX) AVST.00041D

(IZ) AVST.00041I

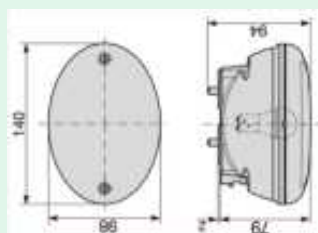

PILOTO DELANTERO JOHN DEERE
 REF. AL171053 (DX) / AL171029 (IZ)
 REF. RECAMBIO TULIPA: AVST.00071T
 CALIDAD ALTERNATIVA
MONTAJE SUPERFICIE M5 C/CONECTOR

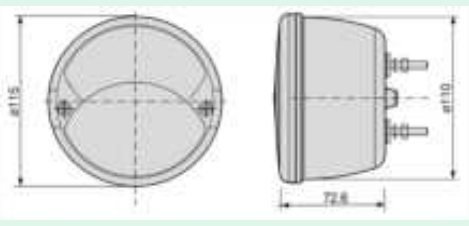

03.0536.0000
PILOTO DELANTERO D./I.
LAMPARAS P21W+R5W
 IP54
 REC. TULIPA: 03.0356.0010

03.0628.0000 (IZ) - 03.0629.0000 (D)
PILOTO DELANTERO
LAMPARAS PY21W+R5W
 IP55
 REC. TULIPA: 03.0588.0200

03.0648.0000 (D) - 03.0649.0000 (IZ)
PILOTO DELANTERO D./I.
LAMPARAS P21W
 IP56 CONECTOR SEAL 2 VIAS
 REC. TULIPA: 03.300.002

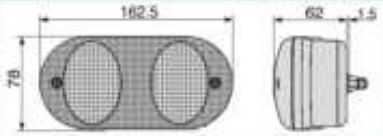



03.0666.0000 (IZ) - 03.0665.0000 (D)
PILOTO DELANTERO
LAMPARAS P21W+R5W
 IP54
 REC. TULIPA: 03.0665.0200





03.0724.0000
PILOTO DELANTERO D./I.
LAMPARAS P21W+R5W
 IP56 CONECTOR SEAL 4 VIAS
 REC. TULIPA: 03.0665.0200





03.0800.0000 (IZ) - 03.0799.0000 (D)
PILOTO DELANTERO 84383203 CNH
LAMPARAS P21W+R5W





AVST.02062  **03.104.000**
PILOTO DELANTERO D./I.
LAMPARAS P21W+R5W
 IP55
 REC. TULIPA: AVST02062T





03.106.000
PILOTO DELANTERO D./I.
LAMPARAS P21W+R5W
 IP54
 REC. TULIPA: 03.104.020





AVST.000131 (IZ)  **03.158.000 (D)**
AVST.00013D (D) **03.159.000 (IZ)**
PILOTO DELANTERO
 IP 55 LAMPARAS P21W+R5W
 REC: AVST.00013DT(D) / AVST.00013IT (IZ)

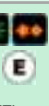

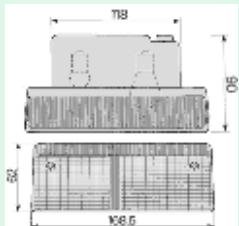

SAME-CASE-MASSEY-LANDINI

03.160.000
PILOTO DELANTERO D./I.
LAMPARAS P21W+R5W
 IP55
 REC. TULIPA: 03.160.200





03.413.000 (D) - 03.412.000 (IZ)
PILOTO DELANTERO
LAMPARAS P21W+R5W
 IP54
 REC. TULIPA: 03.387.001

03.0767.0000
PILOTO DELANTERO D./I.
LAMPARAS PY21W+R5W
 IP55
 REC. TULIPA: 03.0557.0200

03.155.000 (D) - 03.154.000 (IZ)
PILOTO DELANTERO
LAMPARAS P21W+R5W
 IP56
 REC. TULIPA: 03.154.201

03.183.000 (IZ) - 03.182.000 (D)
PILOTO DELANTERO
LAMPARAS P21W+R5W
 IP55
 REC. TULIPA: 03.104.020

03.0755.0000
PILOTO DELANTERO D./I.
TIPO MERCURY LED
 9-32V
CONECTOR SEAL 3 VIAS

03.0989.0000 (IZ) - 03.0988.0000 (D)
PILOTO DELANTERO
TIPO ELLIPSE
 9-32V
CONECTOR SEAL 3 VIAS

AV.03.0015
PILOTO LUZ DIURNA D./I.
 9-32V
C/ SOPORTE
CABLE 200mm

AV.03.0016
PILOTO DELANTERO D./I.
BLANCO / AMBAR
 9-32V
CABLE 200

AV.03.0017
PILOTO DELANTERO D./I.
BLANCO / AMBAR
 9-32V
CABLE 200mm

AV.03.0018
PILOTO DELANTERO D./I.
 9-32V
CABLE 200mm

04.129.000
PILOTO DELANTERO Y TRASERO
LAMPARAS P21W+R5W+P21/W
 IP56
 REC. TULIP. DEL.: 03.104.020 / TRAS. 02.394.020

04.126.000
PILOTO LATERAL D./I.
LAMPARA T10 W5W
 IP55

04.152.000
PILOTO LATERAL D./I.
LAMPARA T10 W5W
 IP56

04.0670.0000
PILOTO LATERAL D./I.
LAMPARA T10 W5W
 IP54
 C/ CONECTOR SEAL 2 VIAS

04.300.000
PILOTO LATERAL DOBLE CARA IZQ
LAMPARAS P21W+R10W
 IP54
 REC. TULIP. DEL.: 04.300.210 / TRAS.: 04.300.220

04.301.000
PILOTO LATERAL DOBLE CARA DRC
LAMPARAS P21W+R10W
 IP54
 REC. TULIP. DEL.: 04.301.220 / TRAS.: 04.301.210

04.320.000 (D) - 04.321.000 (IZ)
PILOTO INTERMITENTE LAT.
LAMPARAS P21W
VERSION 3 AGUJEROS
 REF. IVECO 41221039 (D) / 41221029 (I)

04.0417.0000 (IZ) - 04.0418.0000 (D)
PILOTO INTERMITENTE LAT
LAMPARAS P21W
VERSION 2 AGUJEROS
 REF. IVECO 504098243 (D) / 504098245 (I)

04.0690.0000 (D) - 04.0691.0000 (I)
PILOTO INTERMITENTE LAT.
LAMPARAS P21W
VERSION 3 AGUJEROS
 REF. IVECO 5801572074(D) / 5801572080 (I)

04.0693.0000 (IZ) - 04.0692.0000 (D)
PILOTO INTERMITENTE LAT.
LAMPARAS P21W
VERSION 2 AGUJEROS
 REF. IVECO 5801629858 (D) / 5801629859 (I)



04.0684.0000 (D) - 04.0683.0000 (IZ)
PILOTO INTERMITENTE LATERAL
LAMPARAS P21W IP54
 REC. TULIPA: 04.0475.0002
 REF. IVECO 55801573145(D) / 5801573143 (I)



04.317.000
PILOTO INTERMITENTE LAT. D./I.
LAMPARAS PY21W
 IP55
 REF. IVECO: 500367925

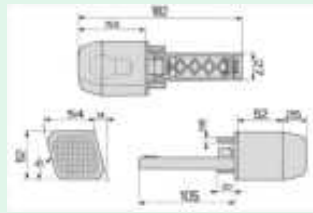

04.122.000
PILOTO LATERAL D./I.
LAMPARAS T10 W3W
 IP55
 REF. TULIPA: 04.115.201

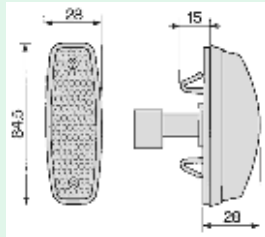

04.0573.0000.41 (12V)
04.0574.0000.42 (24V)
PILOTO LATERAL ADHESIVO
 IP66 / CABLE 250mm

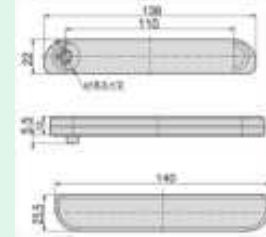

04.0575.0000.41 (12V)
04.0576.0000.42 (24V)
PILOTO LATERAL C/ SOPORTE
 IP66 / CABLE 250mm

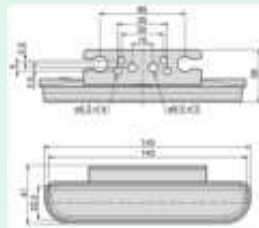

04.0577.0000.41 (12V)
04.0578.0000.42 (24V)
PILOTO LATERAL C/ AGUJEROS (2)
 IP66 / CABLE 250mm

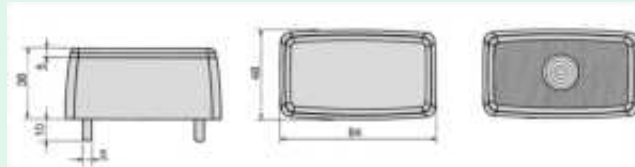
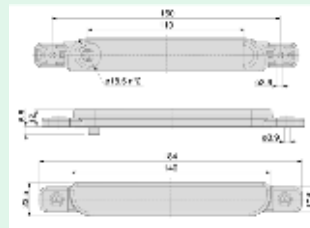

04.197.000
PILOTO LATERAL
LAMPARA T10 W5W
 REC. TULIPA 04.195.100
 REC.PORTALAMP.:30.12.06269

04.198.000
PILOTO LATERAL
LAMPARA T10 W5W
 REC. TULIPA 04.195.100
 REC.PORTALAMP.:30.12.06256

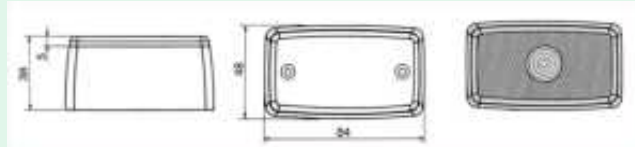

04.201.000
PILOTO LATERAL
LAMPARA T10 W5W
 REC. TULIPA 04.196.100
 REC.PORTALAMP.:30.12.06256

04.202.000
PILOTO LATERAL
LAMPARA T10 W5W
 REC. TULIPA 04.196.100
 REC.PORTALAMP.:30.12.06267

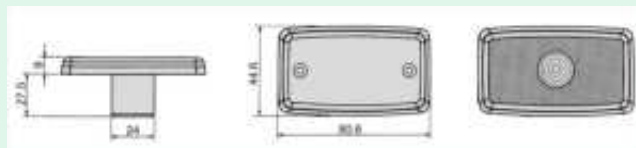

04.203.000
PILOTO LATERAL
LAMPARA T10 W5W
 REC. TULIPA 04.203.100
 REC.PORTALAMP.:30.12.06269

04.204.000
PILOTO LATERAL
LAMPARA T10 W5W
 REC. TULIPA 04.203.100
 REC.PORTALAMP.:30.12.06256

04.205.000
PILOTO LATERAL
LAMPARA T10 W5W
 REC. TULIPA 04.203.100
 REC.PORTALAMP.:30.12.06267



30.12.0676001
 PORTALAMPARAS "T"
 CONECTOR SEAL



30.12.0676101
 PORTALAMPARAS "Y"
 CONECTOR SEAL



30.07.06261
 SOPORTE COLGANTE
 RECTO



30.07.06264
 SOPORTE COLGANTE
 90°

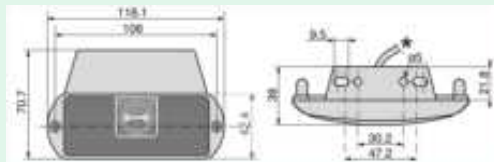

04.0411.0000.41 (12V)
04.0412.0000.42 (24V)
PILOTO LATERAL
C/ OSPORTE 90°
CABLE 500mm

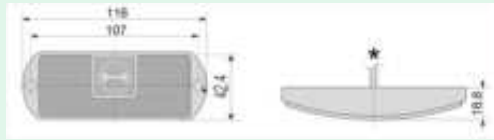

04.0343.0000.41 (12V)
04.0344.0000.42 (24V)
PILOTO LATERAL
FIJACIÓN TORNILLO
CALE 280mm

04.0341.0000.41 (12V)
04.0342.0000.42 (24V)
PILOTO LATERAL
FIJACIÓN TORNILLO
C/ CONECTOR ROSCADO



03.187.000
PILOTO COLGANTE
BLANCO
LAMPARA PLAFONIER C5W

04.107.000
PILOTO COLGANTE
ROJO/BLANCO
LAMPARA PLAFONIER C5W

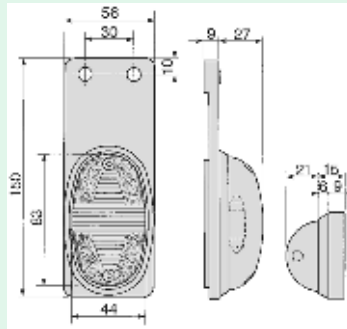

04.106.000
PILOTO COLGANTE
AMBAR
LAMPARA PLAFONIER C5W

02.402.000
PILOTO COLGANTE
ROJO
LAMPARA PLAFONIER C5W



03.149.000
PILOTO GALIBO DEL.
BLANCO
LAMPARA PLAFONIER C5W
TULIPA REC.; 03.149.002

04.111.000
PILOTO GALIBO LAT.
BLANCO/ROJO
LAMPARA PLAFONIER C5W
TULIPA REC.; 04.107.201

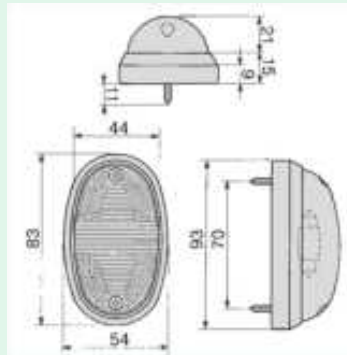

04.108.000
PILOTO GALIBO LAT.
AMBAR
LAMPARA PLAFONIER C5W
TULIPA REC.; 04.108.002

02.266.000
PILOTO GALIBO TRAS.
ROJO
LAMPARA PLAFONIER C5W
TULIPA REC.; 02.266.002

03.0795.0000
PILOTO GALIBO
12V/24V
CABLE 500mm

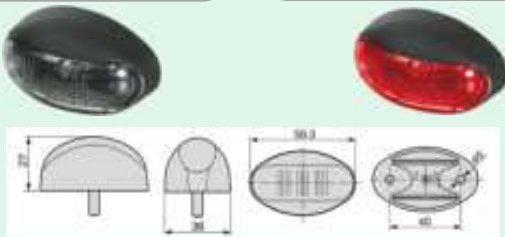

02.1623.0000
PILOTO GALIBO TRAS
12V/24V
CABLE 500mm

04.0351.0000.41 (12V)
04.0352.0000.42 (24V)
PILOTO GALIBO LATERAL
C/ SOPORTE 90° / CABLE 500mm

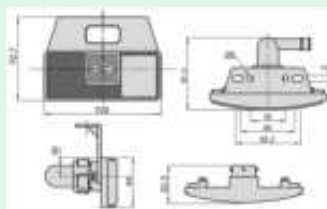

04.0480.0000.41 (12V)
04.0483.0000.42 (24V)
PILOTO GALIBO LATERAL
CABLE 500mm

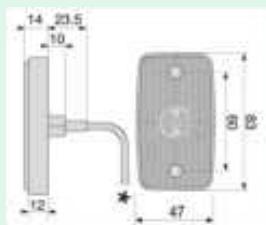

03.0525.0000.41(12V)
03.0526.0000.42(24V)
PILOTO GALIBO DEL.
12V/24V
CABLE 500mm



02.1084.0000.41(12V)
02.1083.0000.42(24V)
PILOTO GALIBO TRAS.
12V/24V
CABLE 500mm



AV.04.0034.42(24V)
PILOTO GALIBO DEL.
CABLE 500mm

AV.04.0035.42(24V)
PILOTO GALIBO TRAS.
CABLE 500mm

03.433.000.42
PILOTO GALIBO DEL.
12V/24V
CABLE 500mm

02.884.000.42
PILOTO GALIBO TRAS.
12V/24V
CABLE 500mm

34.314.000.42
PILOTO GALIBO LAT.
12V/24V
CABLE 500mm

AVFF.02309
PILOTO GALIBO DEL.
12V/24V
CABLE 300mm

AVFF.02310
PILOTO GALIBO LAT.
12V/24V
CABLE 300mm

AVFF.02311
PILOTO GALIBO TRAS.
12V/24V
CABLE 300mm

AVFF.02312
PILOTO GALIBO DEL.
12V/24V
CABLE 300mm

AVFF.02313
PILOTO GALIBO LAT.
12V/24V
CABLE 300mm

AVFF.02314
PILOTO GALIBO TRAS.
12V/24V
CABLE 300mm

AVFF.03006
PILOTO GALIBO DEL.
12V/24V
CABLE 400mm

AVFF.03007
PILOTO GALIBO LAT.
12V/24V
CABLE 400mm

AVFF.03020
PILOTO GALIBO TRAS.
12V/24V
CABLE 400mm

AVFF.03114
PILOTO GALIBO DEL.
12V/24V
CABLE 500mm

AVFF.03633
PILOTO GALIBO LAT.
12V/24V
CABLE 500mm

AVFF.03634
PILOTO GALIBO TRAS.
12V/24V
CABLE 500mm

AVFF.04045
PILOTO GALIBO DEL.
12V/24V
CABLE 400mm

AVFF.04046
PILOTO GALIBO LAT. C/SOP. 90°
12V/24V
CABLE 400mm

AVFF.04047
PILOTO GALIBO TRAS.
12V/24V
CABLE 400mm

04.0681.0000 (D) - 04.0682.0000 (IZ)
PILOTO GALIBO
BLANCO / AMBAR / ROJO
9-32V
CABLE 170mm

04.124.000
PILOTO GALIBO
LAMPARA R5W
REC. TULIPA BLANCA: 04.124.002
REC. TULIPA ROJA: 04.124.001

04.147.000
PILOTO GALIBO
LAMPARA R5W
REC. TULIPA BLANCA: 04.124.002
REC. TULIPA ROJA: 04.124.001

04.148.000
PILOTO GALIBO
LAMPARA R5W
REC. TULIPA BLANCA: 04.124.002
REC. TULIPA ROJA: 04.124.001



04.0491.0000.42
 PILOTO GALIBO 24V
 IP66 / CABLE 180mm
 REC. TULIPA BLANCA: 04.0497.0500.42
 REC. TULIPA ROJA: 04.0501.0500

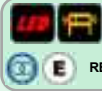
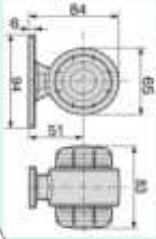

04.0516.0000.42
 PILOTO GALIBO 24V
 IP66 / CABLE 210mm
 REC. TULIPA BLANCA: 04.0497.0500.42
 REC. TULIPA ROJA: 04.0501.0500

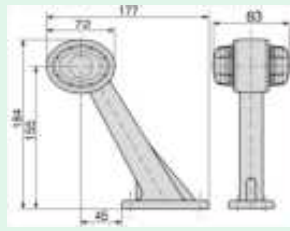

04.0508.0000.42
 PILOTO GALIBO 24V
 IP66 / CABLE 180mm
 REC. TULIPA BLANCA: 04.0497.0500.42
 REC. TULIPA ROJA: 04.0501.0500

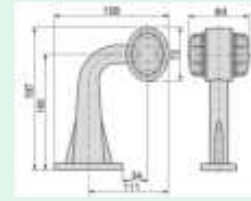

AV.04.0049 (I.)
AV.04.0050 (D.)
 PILOTO GALIBO 10V-30V
 CABLE 300mm MONTAJE BASE HORIZONTAL

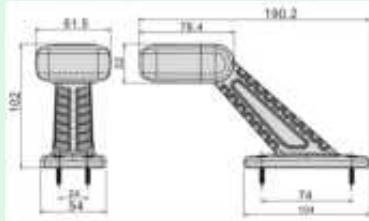

AV.04.0047 (I.)
AV.04.0048 (D.)
 PILOTO GALIBO 10V-30V
 CABLE 300mm

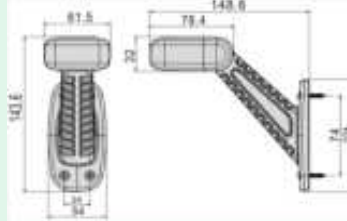

AVFF.04905
 PILOTO GALIBO IZQ
 BLANCO/ROJO/AMBAR
 12V/24V
 CABLE 200mm

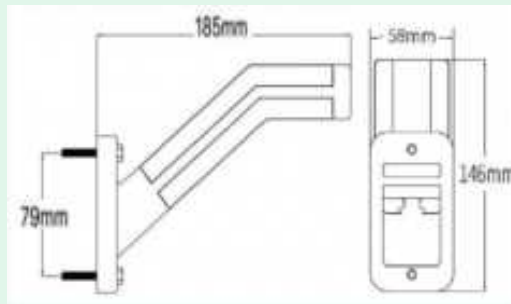

AVFF.04906
 PILOTO GALIBO DRCH
 BLANCO/ROJO/AMBAR
 12V/24V
 CABLE 200mm



AVFF.04507
 PILOTO GALIBO D./I.
 12V/24V
 CABLE 500mm

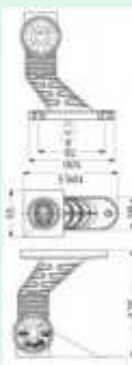
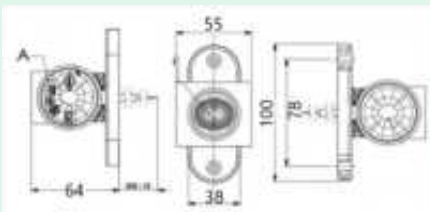

AVFF.04505 (D)
AVFF.04506 (I)
 PILOTO GALIBO
 12V/24V CABLE 500mm



AVFF.04503 (D)
AVFF.04504 (I)
 PILOTO GALIBO
 12V/24V CABLE 500mm

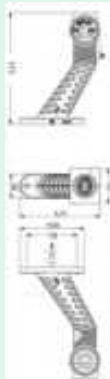

AVFF.04365
 PILOTO GALIB D./I.
 12V/24V
 CABLE 500mm

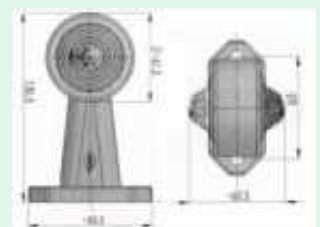

02.1521.0000 (D) - 02.1520.0000 (IZ)
 PILOTO TRASERO
 LAMPARAS P21/5W+P21W
 CONECTOR CABLE 350mm
 REC. TULIPA: 02.1521.0200 (I) - 02.1520.0200 (D)

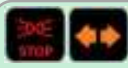

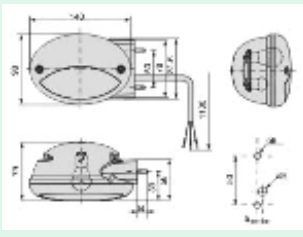
02.1339.0000 (IZ) - 02.1340.0000 (D)
 PILOTO TRASERO CASE MAXXUM / PUMA
 LAMPARAS P21/5W+P21W
 C/PORTALAMPARAS (CONECTOR 27.0943.0000)
 REF. OE CASE: 87536434 (D) - 87536435 (I)







02.943.000 (D) - 02.942.000 (IZ)
 PILOTO TRASERO NEW HOLLAND
 LAMPARAS P21/5W+P21W
 C/PORTALAMPARAS / CONECTOR SEAL
 REF. OE: 84429840 (I) - 84429841 (D)





02.0999.0000 (IZ) - 02.1000.0000 (D)
 PILOTO TRASERO COMPLETO CASE / NEW HOLLAND
 LAMPARAS P21/5W+P21W
 REC. TULIPA: 02.0999.0200 (I) - 02.1000.0200 (D)
 REF. OE: 82026301 (I) - 82026300 (D)





02.1372.0000 (D) 02.1371.0000 (IZ)
 PILOTO TRASERO
 LAMPARAS P21/5W+PY21W+P21W+C5W
 C/ CONECTORES SEAL
 REC. TULIPA: 02.1372.0200 (I) - 02.1371.0200 (D)







AVST.00081D (D) AVST.00081I (IZ)
 PILOTO TRASERO NEW HOLLAND
 LAMPARAS P21/5W+PY21W+P21W+C5W
 C/ CONECTORES SEAL
 REC. TULIPA: AVST.00081DT (D) AVST.00081IT (IZ)





02.180.000 (I) 02.181.000 (D)
 PILOTO TRASERO
 LAMPARAS P21W/R5W
 REC. TULIPA: 02.180.200









02.190.000 (I) 02.191.000 (D)
 PILOTO TRASERO
 LAMPARAS P21W/R5W
 REC. TULIPA: 02.180.200







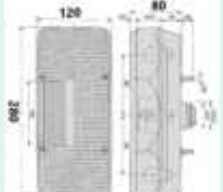
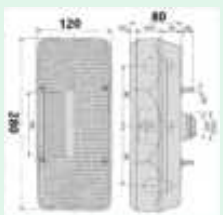

02.200.000 (I) 02.201.000 (D)
 PILOTO TRASERO
 CONECTOR CABLE
 LAMPARAS P21W/R5W
 REC. TULIPA: 02.256.300

02.207.000
 PILOTO TRASERO D.J.
 LAMPARAS P21W+P21W
 CONECTOR CABLE
 REC. TULIPA: 02.206.301

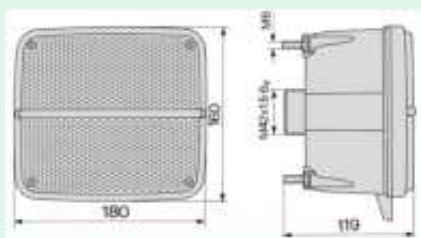
02.224.000 (I) PILOTO TRASERO
CONECTOR CABLE
LAMPARAS P21W/C5W
REC. TULIPA: 02.224.200

02.225.000 (D) PILOTO TRASERO
CONECTOR CABLE
LAMPARAS P21W/C5W
REC. TULIPA: 02.225.200



02.256.000 (I) PILOTO TRASERO
CONECTOR IVECO 8963563
LAMPARAS P21W/C5W
REC. TULIPA: 02.256.300

02.257.000 (D) PILOTO TRASERO
CONECTOR IVECO 8963562
LAMPARAS P21W/C5W
REC. TULIPA: 02.201.300





02.260.000 (D/I) PILOTO TRASERO
CONECTOR CABLE
LAMPARAS P21W/R5W
REC. TULIPA: 02.260.201

02.261.000 (D/I) PILOTO TRASERO
CONECTOR CABLE
LAMPARAS P21W/R5W
REC. TULIPA: 02.260.201



02.280.000 PILOTO TRASERO
C/ TORNILLOS -CONECTOR CABLE
LAMPARAS P21/5W+P21W
REC. TULIPA: 02.280.210

02.281.000 PILOTO TRASERO
CONECTOR CABLE -C/ TORNILLOS
LAMPARAS P21/5W+P21W
REC. TULIPA: 02.281.210

02.486.000 (IZ) - 02.487.000 (D) PILOTO TRASERO LAMBORGHINI / DEUTZ
FIJACIÓN POR GRAPAS LAT.
LAMPARAS P21/5W+R5W
CONECTOR ROSCA FASTON
REC. TULIPA: 02.280.210 (I) - 02.281.210 (D)





02.807.000 (IZ) - 02.808.000 (D) PILOTO TRASERO
FIJACIÓN TORNILLO
LAMPARAS P21W+R5W
CONECTOR CABLE
REC. TULIPA: 02.807.210 (I) - 02.808.210 (D)

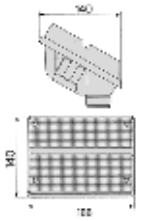

02.284.000 PILOTO TRASERO
SAME / DEUTZ CONECTOR SAE
LAMPARAS P21W/55W
REC. TULIPA: 02.284.210

02.285.000 PILOTO TRASERO
CONECTOR SAE SAME / DEUTZ
LAMPARAS P21W/R5W
REC. TULIPA: 02.285.210

02.350.000 (IZ) PILOTO TRASERO
CONECTOR CABLE/FIJACIÓN TORNILLO
LAMPARAS P21W/5W
REC. TULIPA: 02.350.200

02.351.000 (D) PILOTO TRASERO
CONECTOR CABLE /FIJACION TORNILLO
LAMPARAS P21W/R5W
REC. TULIPA: 02.351.200

AVST.00012I (IZ) PILOTO TRASERO
CONECTOR CABLE/FIJACIÓN TORNILLO
LAMPARAS P21W/5W
REC. TULIPA: AVST.00012TI

AVST.00012D (D) PILOTO TRASERO
CONECTOR CABLE /FIJACION TORNILLO
LAMPARAS P21W/R5W
REC. TULIPA: AVST.00012DT



02.357.000 (D) - 02.356.0000 (IZ) PILOTO TRASERO
LAMPARAS P21/5W+P21W
CONECTOR CABLE
REC. TULIPA: 02.356.200 (D/I)





02.430.000 (D/I) PILOTO TRASERO
CONECTOR CABLE
LAMPARAS P21W/55W
REC. TULIPA: 02.356.200

02.605.000 (D/I) PILOTO TRASERO
CONECTOR CABLE C/ TORNILLOS M5
LAMPARAS P21W/R5W
REC. TULIPA: 02.356.200





02.383.000 (D) - 02.382.000 (IZ)
 PILOTO TRASERO
 LAMPARAS P21/5W+P21W
 CONECTOR CABLE / CARCASA TRAS. 45°
 REC. TULIPA: 02.382.210 (I) - 02.383.210 (D)





02.650.000 (D) - 02.651.000 (IZ)
 PILOTO TRASERO
 LAMPARAS P21/5W+P21W
 CONECTOR CABLE / CARCASA TRAS. 45°
 REC. TULIPA: 02.651.210 (I) - 02.650.210 (D)





02.385.000 (D) - 02.384.000 (IZ)
 PILOTO TRASERO
 LAMPARAS P21/5W+P21W
 CONECTOR CABLE / CARCASA TRAS. 30°
 REC. TULIPA: 02.382.210 (I) - 02.383.210 (D)







02.219.000 (D./I.)
 PILOTO TRASERO COMPLETO
 LAMPARAS P21/5W+P21W
 REC. TULIPA: 02.218.310



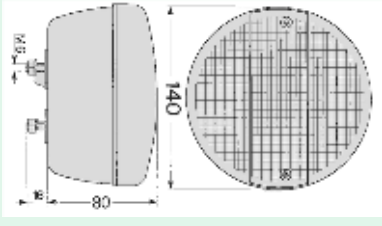

02.221.000
 PILOTO TRASERO
 LAMPARAS P21/5W+P21W
 CONECTOR CABLE
 REC. TULIPA: 02.220.310)

02.780.000 (D./I.)
 PILOTO TRASERO
 JOHN DEERE
 (SIN PORTALAMPARAS)
 REF. OE: RE67285
 VERSIÓN COBO







AVST.01040 (D./I.)
 PILOTO TRASERO
 JOHN DEERE
 COMPLETO C/CONECTOR
 REF. OE: AL112964
 VERSIÓN HELLA
 REC. TUL AVST.01040T







AVST02060 (D./I.)
 PILOTO TRASERO
 LAMPARAS P21/5W+P21W
 CONECTOR CABLE
 REC. TULIPA: AVST.02060T





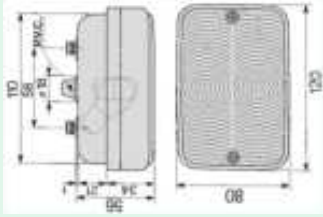

02.394.000 (D./I.)
 PILOTO TRASERO
 LAMPARAS P21/5W+P21W
 CONECTOR CABLE
 REC. TULIPA: 02.394.020

02.447.000 (D./I.)
 PILOTO TRASERO
 LAMPARAS P21/5W+P21W
 CONECTOR CABLE
 REC. TULIPA: 02.394.020

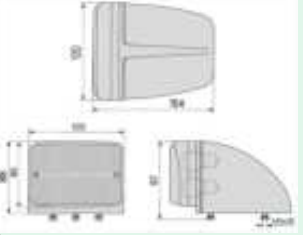

02.654.000 (IZ)
 PILOTO TRASERO
 CONECTOR CABLE
 LAMPARAS P21W/55W
 REC. TULIPA: 02.654.200



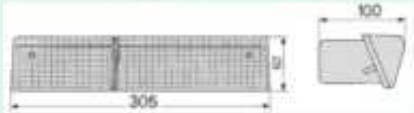

02.655.000 (D)
 PILOTO TRASERO
 CONECTOR CABLE
 LAMPARAS P21W/R5W
 REC. TULIPA: 02.655.200

02.539.000 (D./I.—FIJACIÓN GRAPAS)
02.591.000 (D./I.—FIJACIÓN TORNILLO)
02.604.000 (D./I.—FIJACIÓN TORNILLO + CONECTOR)
 PILOTO TRASERO
 LAMPARAS P21/5W+P21W CONECTOR CABLE

AVST.02061 (D./I.—FIJACIÓN GRAPAS)
AVST.02061V (D./I.—FIJACIÓN TORNILLO)
 PILOTO TRASERO
 LAMPARAS P21/5W+P21W CONECTOR CABLE
 REC. TULIPA: AVST.02061T

02.625.000 (IZ) - 02.624.000 (D)
 PILOTO TRASERO
 LAMPARAS P21/5W / P21W
 CONECTOR AMP REDONDO
 REC. TULIPA: 02.624.130 (D)—02.625.130 (I)

02.728.000
 PILOTO TRASERO D./I.
 LAMPARAS P21/5W / P21W
 CONECTOR CABLE
 REC. TULIPA: 02.728.210

02.752.000
 PILOTO TRASERO D./I.
 LAMPARAS P21/5W / P21W
 CONECTOR AMP REDONDO
 REC. TULIPA: 02.728.210

02.889.000 (IZ)—02.890.000 (D)
 PILOTO TRASERO
 LAMPARAS P21W/P21W
 CONECTOR FASTON
 REC. TULIPA: 02.889.002 (IZ) - 02.890.002 (D)

02.528.000 (IZ) - 02.529.000 (D)
 PILOTO TRASERO
 LAMPARAS P21/5W+P21W
 CONECTOR CABLE
 REC. TULIPA: 02.356.200

02.533.000 (IZ) - 02.534.000 (D)
 PILOTO TRASERO D./I.
 LAMPARAS P21/5W+P21W
 CONECTOR CABLE
 REC. TULIPA: 02.356.200

02.1065.000 (I)
 PILOTO TRASERO
 CABLE + CONECTOR AMP
 LAMPARAS P21/5W/P21W/R5W
 REC. TULIPA: 02.987.200

02.1064.000(D)
 PILOTO TRASERO
 CABLE + CONECTOR AMP
 LAMPARAS P21/5W/P21W/R5W
 REC. TULIPA: 02.882.200

02.883.000 (I)
 PILOTO TRASERO
 PASACABLES
 LAMPARAS P21/5W/P21W/R5W
 REC. TULIPA: 02.883.200

02.882.000(D)
 PILOTO TRASERO
 PASACABLES
 LAMPARAS P21/5W/P21W/R5W
 REC. TULIPA: 02.882.200

02.887.000 (IZ)
 PILOTO TRASERO
 LAMPARAS P21/5W+P21W+R5W
 CONECTOR CABLE
 REC. TULIPA: 02.887.200(IZ)

02.885.000 (D)
 PILOTO TRASERO
 LAMPARAS P21W+P21W+R5W
 CONECTOR CABLE
 REC. TULIPA: 02.885.200

02.1473.000(D)
02.1472.000(IZ)
PILOTO TRASERO COMPLETO IVECO DAILY
LAMPARAS P21/5W+P21W
CONECTOR IVECO
REC. TULIPA: 02.1472.0200 (I) - 02.1473.0200 (D)







02.1474.000 (I)
PILOTO TRASERO IVECO DAILY
COMPLETO CON PORTALAMPARAS
REF. OE 69500591
REF. S/ PORTALAMP.: 02.1474.1000

02.1475.000 (D)
PILOTO TRASERO IVECO DAILY
COMPLETO CON PORTALAMPARAS
REF. OE 69500590
REF. S/ PORTALAMP.: 02.1475.1000





02.1044.000(IZ)
PILOTO TRASERO
LAMPARAS P21/5W+P21W+R5W+R10W
CONECTOR IVECO
REC. TULIPA: 02.1113.0025







02.1043.0000 (D)
PILOTO TRASERO COMPLETO
LAMPARAS P21/5W+P21W+R10W+R5W
CONECTOR IVECO
REC. TULIPA: 02.1114.0025





02.898.000
PILOTO INTERMITENTE
DEL/TRAS.
LAMPARA P21W
CONECTOR SEAL 27.0958.0000
REC. TULIPA: 02.898.101







02.899.000
PILOTO MARCHA ATRAS
LAMPARA P21W
CONECTOR SEAL 27.0958.0000
REC. TULIPA: 02.899.001



02.896.000
PILOTO POSICIÓN TRAS
LAMPARA P21W
CONECTOR SEAL 27.0958.0000
REC. TULIPA: 02.896.001

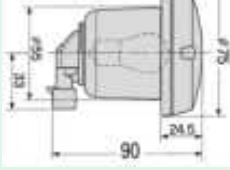

02.897.000
PILOTO POSICIÓN Y FRENO
LAMPARA P21W
CONECTOR SEAL 27.0958.0000
REC. TULIPA: 02.897.101



02.614.000
PILOTO TRASERO
MARCHA ATRAS
LAMPARAS P21W
REC. TULIPA: 02.276.300

02.616.000
PILOTO TRASERO
ANTINEBLA
LAMPARAS P21W
REC. TULIPA: 02.241.300





AVST.01063D (DX) AVST.01063I (IZ)
PILOTO TRASERO JOHN DEERE
REF. OE AL171077 (DX) / REF OE AL215076
COMPLETO CON PORTALAMPARAS





AVST.030010
PILOTO TRASERO D./I. JCB
LAMPARAS P21/5W+P21W
CONECTOR DT
REF. OE: 700/50018

AVST.030010L
PILOTO TRASERO D./I. JCB
VERSIÓN LED
CONECTOR DT
REF. OE: 700/50018





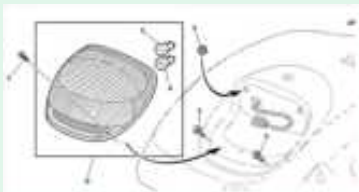

AVST.01061S
PILOTO TRASERO D./I. JOHN DEERE
LAMPARAS P21/5W+P21W
CON PORTALAMPARAS
REF. OE: AL210180



AVST.00035

PILOTO TRASERO NEW HOLLAND / FIAT
 REF. OE 47403613
 REF. RECAMBIO TULIPA: AVST.00035T
 DERECHO / IZQUIERDO
 CALIDAD ALTERNATIVA
 CON SOPORTE PARA TUBO

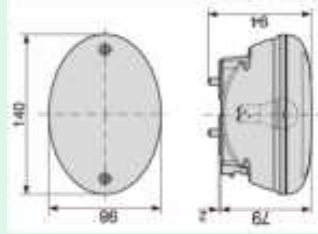

E



AVST.00074

PILOTO TRASERO NEW HOLLAND / FIAT
 REF. OE 5099643B
 REF. RECAMBIO TULIPA: AVST.00035T
 DERECHO / IZQUIERDO
 CALIDAD ALTERNATIVA
 SUJECION LATERAL

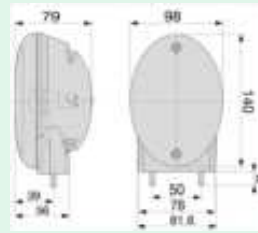

E



AVST.00076

PILOTO TRASERO NEW HOLLAND / FIAT
 REF. OE 5098225
 REF. RECAMBIO TULIPA: AVST.00035T
 DERECHO / IZQUIERDO
 CALIDAD ALTERNATIVA
 SUJECION LATERAL SOPORTE TUBO

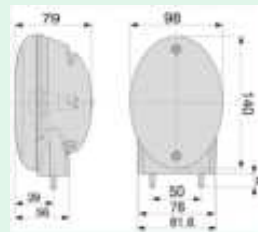

E



AVST.00077

PILOTO DELANTERO NEW HOLLAND / FIAT
 REF. UNIVERSAL
 REF. RECAMBIO TULIPA: AVST.00035T
 DERECHO / IZQUIERDO
 CALIDAD ALTERNATIVA
 MONTAJE SUPERFICIE M5

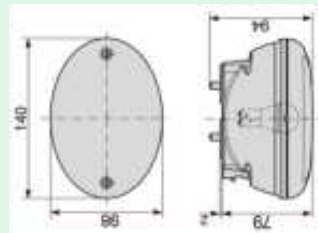

E



AVST.00082C (ROJA)

AVST.00083C (AMBAR)

RECAMBIO TULIPA PILOTOS OVAL



E

LED **STOP** **IP67**
04.0737.0000.41 (12V)
04.0737.0000.42 (24V)
 PILOTO INTERMITENTE D./I.
 FIJACIÓN TORNILLOS
 C/ CONECTOR 27.0958.0000

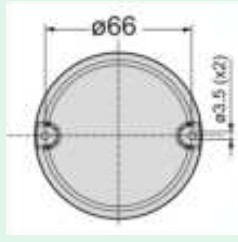

LED **STOP**
02.1766.0000.41 (12V)
02.1766.0000.42 (24V)
 PILOTO TRASERO D./I.
 FIJACIÓN TORNILLOS
 C/ CONECTOR 27.0905.0000

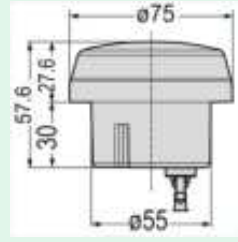

LED **STOP** **IP67**
02.1767.0000.41 (12V)
02.1767.0000.42 (24V)
 PILOTO TRASERO D./I.
 FIJACIÓN TORNILLOS
 C/ CONECTOR 27.0905.0000



AV.02.0171 Ø95mm
 PILOTO TRASERO D./I.
 10/30V
 CONECTOR CABLE
 FIJACIÓN TORNILLOS

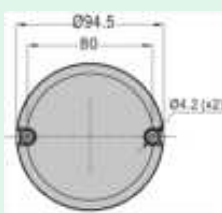

AV.02.0178 Ø95mm
 PILOTO TRASERO
 10/30V
 CONECTOR CABLE
 FIJACIÓN TORNILLOS

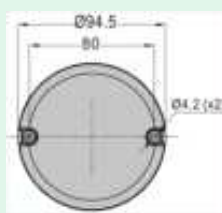

AV.02.0179 Ø95mm
 PILOTO TRASERO
 10/30V
 CONECTOR CABLE
 FIJACIÓN TORNILLOS

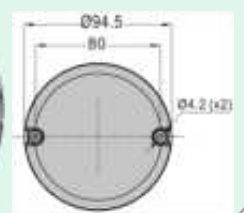

LED **STOP** **IP67**
Ø105mm 02.1568.0000
 PILOTO TRASERO VERSIÓN MERCURY
 9/32V
 CONECTOR:27.0905.0000

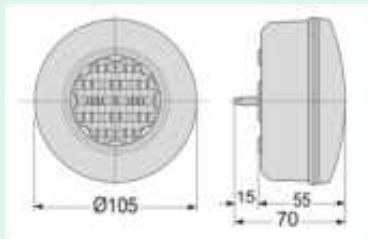

02.1702.0000 Ø105mm
 PILOTO TRASERO D./I.
 9/32V
 CONECTOR CABLE



AVPH.02704 Ø122mm
 PILOTO TRASERO 122 Ø 12V/24V
 CONECTOR CABLE
 FIJACIÓN TORNILLO
 12 LED

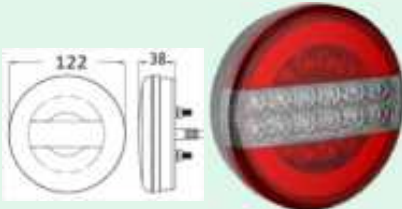

AVPH.02705 Ø122mm
 PILOTO TRASERO 122 Ø 12V/24V
 CONECTOR CABLE
 FIJACIÓN TORNILLO
 12 LED

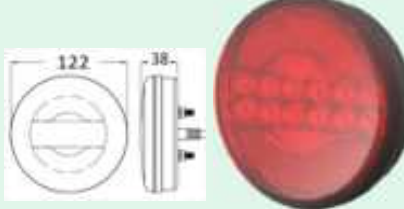

AVPH.02707 Ø122mm
 PILOTO TRASERO 122 Ø 12V/24V
 CONECTOR CABLE
 FIJACIÓN TORNILLO
 12 LED

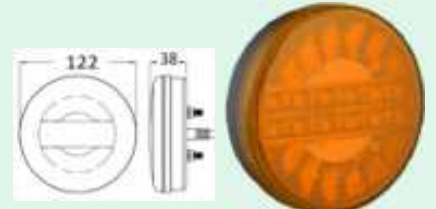

AVPH.02706 Ø122mm
 PILOTO TRASERO 122 Ø 12V/24V
 CONECTOR CABLE
 FIJACIÓN TORNILLO
 12 LED



AVPH.02709 Ø122mm
 PILOTO TRASERO 122 Ø 12V/24V
 CONECTOR CABLE
 FIJACIÓN TORNILLO
 12 LED



AVPH.02708 Ø122mm
 PILOTO TRASERO 122 Ø 12V/24V
 CONECTOR CABLE
 FIJACIÓN TORNILLO
 12 LED



AVFF.02837 PILOTO TRASERO D./L.—12V/24V CONECTOR CALBE FIJACIÓN TORNILLOS

AVFF.02838 PILOTO TRASERO 12V/24V CONECTOR CALBE FIJACIÓN TORNILLOS

AVFF.02948 (D) Ø140mm
AVFF.02947 (I) Ø140mm
PILOTO TRASERO 12V/24V CONECTOR CABLE FIJACIÓN TORNILLO

AVPH.02074 Ø140mm
AV.02.0074 Ø140mm
PILOTO TRASERO 12V/24V CONECTOR CABLE FIJACIÓN TORNILLO

AVFF.02203 Ø140mm
PILOTO TRASERO 12V/24V CONECTOR CABLE FIJACIÓN TORNILLO

AVPH.02170 Ø140mm
AV.02.0170 Ø140mm
PILOTO TRASERO 12V/24V CONECTOR CABLE FIJACIÓN TORNILLO

AVPH.02075 Ø140mm
AV.02.0075 Ø140mm
PILOTO TRASERO 12V/24V CONECTOR CABLE FIJACIÓN TORNILLO

AV.02.0077 Ø140mm
AV.02.0174 Ø140mm
PILOTO TRASERO 12V/24V CONECTOR CABLE FIJACIÓN TORNILLO

AV.02.0076 Ø140mm
PILOTO TRASERO 12V/24V CONECTOR CABLE FIJACIÓN TORNILLO

COBO 02.1847.0000 (D) - 02.1848.0000 (I)
PILOTO TRASERO ELLIPSE 10-30V CONEXIÓN SEAL 3 VIAS

AV.02.0204 PILOTO TRASERO CONEXIÓN CALBE FIJACIÓN TORNILLO 12V/24V

AV.02.0159 PILOTO TRASERO CONEXIÓN CABLE FIJACIÓN TORNILLO 12V/24V

AVFF.02016 PILOTO TRASERO CONECTOR CABLE FIJACIÓN TORNILLO 12V/24V IP65

AVFF.02017 PILOTO TRASERO CONECTOR CABLE FIJACIÓN TORNILLOS IP65 12V/24V

AVFF.02070 PILOTO TRASERO CONECTOR CABLE FIJACIÓN TORNILLO IP65 12V/24V

AV.02.0177
 PILOTO TRASERO
 CONEXIÓN CABLE
 FIJACIÓN TORNILLO
 12V/24V

LED, REFLEX, IP67, COBO

AVFF.02531
 PILOTO TRASERO
 CONECTOR CABLE
 FIJACIÓN TORNILLO
 12V/24V

AVFF.02532
 PILOTO TRASERO
 CONECTOR CABLE
 FIJACIÓN TORNILLOS
 12V/24V

LED, REFLEX, IP67, L.M., COBO

AVFF.02503 (ANTINEBLA)
AVFF.02502 (M. ATRÁS)
 PILOTO TRASERO / CONEXIÓN CABLE / FIJACIÓN TORNILLO M6*30
 12V/24V

COBO

AV.02.0167
 PILOTO TRASERO
 CONEXIÓN CALBE
 FIJACIÓN TORNILLO
 12V/24V

LED, STOP, REFLEX, IP67, COBO

AVFF.02839 / AVPH.02839
 PILOTO TRASERO D./I. CONEXIÓN CABLE FIJACIÓN TORNILLO 2V/24V

AVPH.02839R (C/M. ATRÁS)

LED, STOP, REFLEX, IP67, COBO

AVFF.02160
AV.02.0160
 PILOTO TRASERO 12V/24V
 CONECTOR CABLE
 FIJACIÓN TORNILLO

LED, STOP, REFLEX, IP67, COBO

AV.02.0161
 PILOTO TRASERO D./I.
 CONECTOR CABLE
 FIJACIÓN TORNILLO
 12V/24V

LED, STOP, REFLEX, IP67, COBO

AV.02.0163 (I)
AV.02.0162 (D)
 PILOTO TRASERO 12V/24V
 CONECTOR CABLE
 FIJACIÓN TORNILLO

LED, STOP, REFLEX, IP67, COBO

AV.02.0223
 (D./I.) PILOTO TRASERO
 CONECTOR CABLE
 FIJACIÓN TORNILLO
 12V/24V

COBO

AVFF.02828 (IZ)
AVFF.02829 (D)
 PILOTO TRASERO 12V/24V
 CONECTOR CABLE / FIJACIÓN TORNILLO

LED, STOP, REFLEX, IP67, COBO

AVFF.02864 (D)
AVFF.02863 (IZ)
 PILOTO TRASERO
 C/LUZ MATRICULA CONECTOR LATERAL 12V/24V
 FIJACION TORNILLO M8

AVFF.02824 (IZ)
AVFF.02825 (D)
 PILOTO TRASERO
 CONECTOR CABLE 12V/24V
 FIJACION TORNILLO

AVFF.02873
 PILOTO TRASERO D./I.
 CONECTOR CABLE
 FIJACION TORNILLO

AVFF.02874 (IZ)
AVFF.02875 (D)
 PILOTO TRASERO
 CONEXIÓN CABEL
 FIJACIÓN TORNILLO

AVFF.02891
 PILOTO TRASERO D./I.
 12V/24V
 CONECTOR CABLE
 FIJACIÓN TORNILLO

AVFF.02301
 PILOTO TRASERO D./I.
 CONECTOR CABLE
 FIJACIÓN TORNILLO M6

AVFF.02320
 PILOTO TRASERO
 CONECTOR CABLE
 FIJACIÓN TORNILLO M6

AVFF.02832 (D)
AVFF.02831 (IZ)
 PILOTO TRASERO REMOLQUE
 CONECTOR CABLE
 FIJACIÓN TORNILLO M6

AV.02.0173 (D)
AV.02.0172 (IZ)
 PILOTO TRASERO REMOLQUE
 CONECTOR CABLE
 FIJACIÓN TORNILLO M6

AV.02.0130 (IZ)
AV.02.0131 (D)
 PILOTO TRASERO REMOLQUE 12V/24V
 CONECTOR 27.0856.0000 / FIJACIÓN TORNILLO

PILOTOS TRASEROS LED

LED STOP REFLEX IP67 **AV.02.0202 (D)**
AV.02.0201 (IZ)
 PILOTO TRASERO REMOLQUE
 24V / CONECTOR FASTON
 FIJACIÓN TORNILLO

COBO

LED STOP REFLEX IP67 **AV.02.0189 (D)**
AV.02.0188 (IZ)
 PILOTO TRASERO REMOLQUE
 CONECTOR FASTON
 FIJACIÓN TORNILLO

COBO

LED STOP REFLEX IP67 **AVFF.02813 (IZ)**
AVFF.02815 (D)
 PILOTO TRASERO REMOLQUE
 12V/24V / CONEXIÓN CABLE
 FIJACIÓN TORNILLO

E

LED STOP REFLEX IP67 **AVFF.02911 (IZ)**
AVFF.02912 (D)
 PILOTO TRASERO REMOLQUE 12V/24V
 FIJACIÓN TORNILLO
 CONEXIÓN CABLE (LUZ MATRI. LAT)

E

LED STOP REFLEX IP67 **AVFF.02818 (IZ)**
AVFF.02819 (D)
 PILOTO TRASERO REMOLQUE
 12V/24V CONEXIÓN CABLE
 FIJACIÓN TORNILLO

E

LED STOP REFLEX IP67 **AVFF.02822 (IZ)**
AVFF.02823 (D)
 PILOTO TRASERO REMOLQUE
 12V/24V CONEXIÓN CABLE
 FIJACIÓN TORNILLO

E

LED STOP REFLEX IP67 **AVFF.02859 (IZ)**
AVFF.02860 (D)
 PILOTO TRASERO REMOLQUE
 12V/24V CONEXIÓN CABLE
 FIJACIÓN TORNILLO

E

LED STOP REFLEX IP67 **AVFF.02918 (IZ)**
AVFF.02919 (D)
 PILOTO TRASERO REMOLQUE
 12V/24V CONEXIÓN CABLE
 FIJACIÓN TORNILLO

E

LED STOP REFLEX IP67 **AVFF.02404**
AVFF.02405
 PILOTO TRASERO REMOLQUE
 FIJACIÓN TORNILLO / CONEXIÓN CABLE

E

LED STOP REFLEX IP67 **AVFF.02907 (IZ)**
AVFF.02908 (D)
 PILOTO TRASERO REMOLQUE
 12V/24V CONEXIÓN CABLE
 FIJACIÓN TORNILLO

E

novedae!

LED 3000K STOP 3000K STOP 3000K STOP 3000K STOP REFLEX IP67

AVFF.02422 (IZ)
AVFF.02423 (D)
 PILOTO TRASERO 12V/24V
 FIJACIÓN TONRILLO
 CONEXIÓN CABLE

E

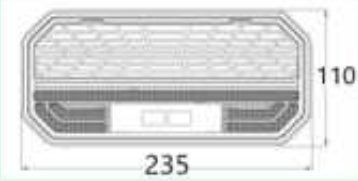

AVFF.02855
 PILOTOS TRASEROS REMOLQUE
 C/ IMAN
 CONEXIÓN CLAVIJA 7 POLOS
 7.5MTS

LED 3000K STOP 3000K STOP L.M. REFLEX

E

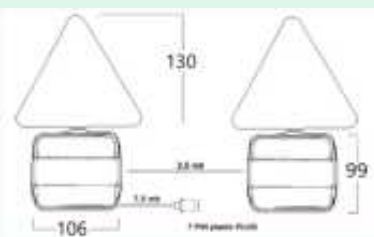

LED 3000K STOP 3000K STOP L.M. REFLEX

AVFF.02856
 PILOTOS TRASEROS REMOLQUE
 C/ IMAN
 CONEXIÓN CLAVIJA 7 POLOS
 7.5MTS

E

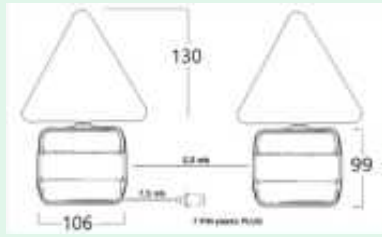

AVFF.02857
 PILOTOS TRASEROS
 C/ IMAN
 CONEXIÓN CLAVIJA 7 POLOS
 7.5MTS

LED 3000K STOP 3000K STOP L.M. REFLEX

E

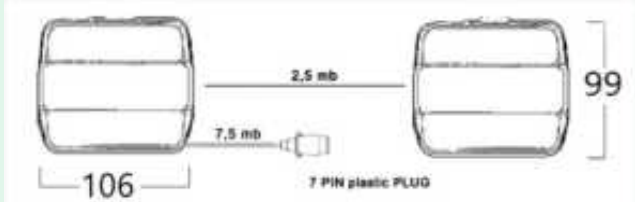

LED 3000K STOP 3000K STOP L.M. REFLEX IP67

AVPH.02703
 KIT INALAMBRICO PILOTO TRASERO D./I.
 BATERIAS 5000mAh / RADIO 30mts
 CONECTOR WIRELESS 2.4 Ghz / 7 POLOS EU
 4 IMANES VERTICAL / HORIZONTAL

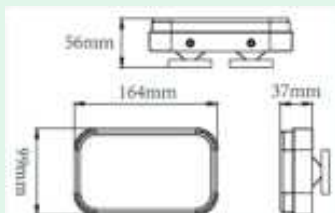

novedae!

PILOTOS TRASEROS LED

DEAFF  **novedad!**

AVFF.02014 (IZ / D)
 PILOTO TRASERO 12V/24V
 FIJACION TORNILLO
 CONEXION CABLE
 R10-R14B
 E

LED STOP IP67



DEAFF  **novedad!**

AVFF.02501 (IZQ / D)
 PILOTO TRASERO 12V
 C/ LUZ MATRICULA
 UNIVERSAL
 FIJACION TORNILLO
 E

LED STOP L.M. REFLEX



DEAFF  **novedad!**

AVPH.T1C
 JUEGO PILOTOS TRASEROS 12V/24V
 CONEXION CABLE FIJACION TORNILLO
 E

LED STOP REFLEX IP67 L.M.



DEAFF  **novedad!**

AVPH.27603I (IZ) - AVPH.27603D (DR)
 PILOTO TRASERO REMOLQUE
 12V/24V
 CONEXION CABLE / MONTAJE TORNILLOS
 E



LED STOP REFLEX IP67



DEAFF  **novedad!**

AVPH.02745I (IZ) - AVPH.02745D (DR)
 PILOTO TRASERO
 12V/24V
 CONEXION CABLE / MONTAJE TORNILLOS
 E

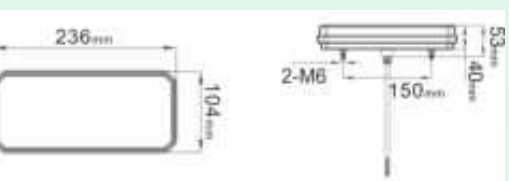
LED STOP REFLEX IP67

35.088.13
 ROTATIVO 12V
 LAMPARA H1
 MONTAJE FIJO

12V ROTATIVO HALOGEN R65 R10

COBO

35.090.13
 ROTATIVO 12V
 LAMPARA H1
 IMAN+CABLE

12V ROTATIVO IMAN HALOGEN R65 R10

COBO

35.091.13
 ROTATIVO 12V
 LAMPARA H1
 MONTAJE MASTIL

12V ROTATIVO HALOGEN R65 R10

COBO

35.0142.0000.01
 ROTATIVO 24V
 LAMPARA H1
 MONTAJE FIJO / CONECTOR R.V.I.

12V ROTATIVO HALOGEN R65 R10

COBO

35.0110.0000
 DESTELLANTE XENON
 CONEX. CABLE
 29,7W-13,5V / 39,2W-28V

12V FLASH 24V FLASH XENON R65

COBO

35.0111.0000
 DESTELLANTE XENON
 IMAN+CABLE
 29,7W-13,5V / 39,2W-28V

12V FLASH 24V FLASH XENON IMAN R65

COBO

35.0112.0000
 DESTELLANTE XENON
 MONTAJE MASTIL
 29,7W-13,5V / 39,2W-28V

12V FLASH 24V FLASH XENON R65

COBO

35.0135.0000
 DESTELLANTE XENON
 MONTAJE FIJO / CONECTOR SEAL
 29,7W-13,5V / 39,2W-28V

12V FLASH 24V FLASH XENON R65

COBO

35.1002.0001
 RECAMBIO CUPULA
 ROTATIVO GAMA HALOGEN
 35.0142.0000 RECAMBIO AMBAR

COBO

60.35.45406
 LAMPARA RECAMBIO
 DESTELLANTE XENON COBO
 12V/24V

COBO

LED **12V** **24V** **R65** **R10** **IP67** **35.3000.0000**
 DESTELLANTE
 MONTAJE FIJO
 12V/24V

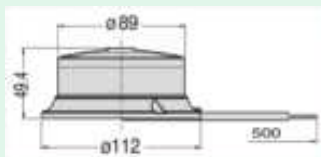

LED **12V** **24V** **R65** **R10** **IP67** **35.3001.0000**
 DESTELLANTE
 IMÁN+CABLE
 12V/24V

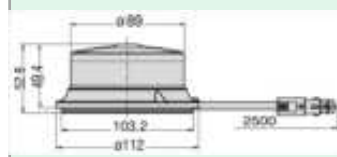

LED **12V** **24V** **R65** **R10** **IP67** **35.3002.0000**
 DESTELLANTE
 MONTAJE FIJO
 12V/24V

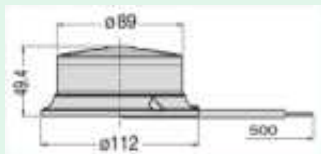

LED **12V** **24V** **R65** **R10** **IP67** **35.3003.0000**
 DESTELLANTE
 IMÁN+CABLE
 12V/24V

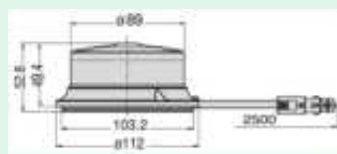

LED **12V** **24V** **R65** **R10** **IP67** **35.3006.0000**
 DESTELLANTE LED
 FIJACION MASTIL
 FLEX
 12V/24V



LED **10V** **110V** **R65** **R10** **IP67** **35.3007.0000**
 DESTELLANTE
 ESPECIAL CARRETILLAS
 MONTAJE FIJO
 10V-110V

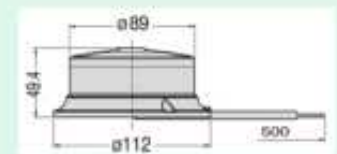

LED **10V** **110V** **R65** **R10** **IP67** **35.3008.0000**
 DESTELLANTE
 ESPECIAL CARRETILLAS
 IMÁN+CABLE
 10V-110V

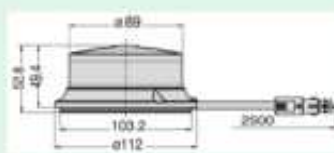

LED **10V** **110V** **R65** **R10** **IP67** **35.3009.0000**
 DESTELLANTE
 ESPECIAL CARRETILLAS
 CONEXIÓN MASTIL FLEX.
 10V-110V



LED **12V** **24V** **R10** **IP67** **35.3004.0000**
 DESTELLANTE
 MONTAJE FIJO
 12V/24V

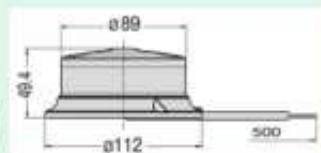

LED **12V** **24V** **R10** **IP67** **35.3005.0000**
 DESTELLANTE
 IMÁN+CABLE
 12V/24V

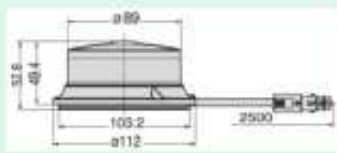

LED 12V FLASH 24V FLASH R10
E COBO

35.8001.0000
DESTELLANTE LED
ESPECIAL CARRETTILLAS
10V-110V

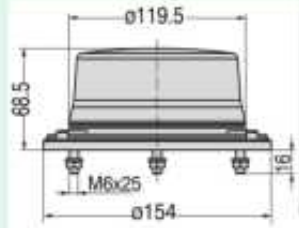

35.8002.0000 LED 12V FLASH 24V FLASH R65 R10 IP67
DESTELLANTE LED
MONTAJE FIJO
CABLE 130mm
E COBO



LED 12V FLASH 24V FLASH U IMAN R65 R10 IP67
E COBO

35.8004.0000
DESTELLANTE LED
IMAN+CABLE (80KM/H)
12V/24V

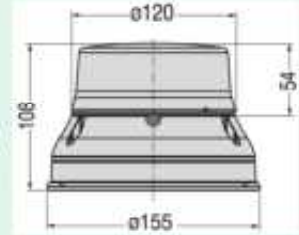

35.8006.0000 LED 12V FLASH 24V FLASH R65 R10 IP67
DESTELLANTE LED
MONTAJE MASTIL FLEX
12V/24V
E COBO



LED 12V FLASH 24V FLASH U IMAN R65 R10 IP67
E COBO

35.8021.0000
DESTELLANTE LED
IMAN(3)+CALBE (250KM/H)
12V/24V



35.8014.0000 LED ROTATIVO ROTATIVO R10 R65 IP67
ROTATIVO LED
MONTAJE MASTIL
12V/24V
E COBO



LED FLASH FLASH R10 R65 IP67
E COBO

35.8007.0000
DESTELLANTE LED
MONTAJE MASTIL FLEX
CRISTAL BLANCO/LUZ AZUL



35.8009.0000 LED FLASH FLASH R10 R65 IP67
DESTELLANTE LED
MONTAJE MASTIL FIJO
CRISTAL BLANCO / LUZ AZUL
E COBO



LED FLASH FLASH U IMAN R10 R65 IP67
E COBO

35.8020.0000
DESTELLANTE LED
IMAN(3)+CALBE (250KM/H)
CRISTAL BLANCO / LUZ AZUL



35.8024.0000 LED FLASH FLASH R10 R65 IP67
DESTELLANTE LED
MONTAJE FIJO
12V / 24V
E COBO



ROTATIVOS & DESTELLANTES LED

AVFF.00001 ROTATIVO LED MONTAJE MASTIL ROSCA 12V/24V

LED 12V ROTATIVO 24V ROTATIVO R10 R65 IP67

AVFF.35005 ROTATIVO LED MONTAJE FIJO 12V/24V

LED 12V ROTATIVO 24V ROTATIVO R10 R65 IP67

AVFF.35006 ROTATIVO LED MONTAJE MASTIL FLEX 12V/24V

LED 12V ROTATIVO 24V ROTATIVO R10 R65 IP67

AVFF.00004 ROTATIVO LED IMÁN+CABLE 12V/24V C/INTERRUPTOR ON-OFF

LED 12V ROTATIVO 24V ROTATIVO IMÁN R10 R65 IP67

AVFF.00004D DESTELLANTE LED IMÁN+CABLE 12V/24V 4 MODOS FLASH

LED 12V FLASH 24V FLASH IMÁN R65 R10 IP67

AVFF.00024 ROTATIVO LED MONTAJE MASTIL 12V/24V

LED 12V ROTATIVO 24V ROTATIVO R10 R65 IP67

AVFF.00054 DESTELLANTE LED IMÁN+CABLE 12V/24V 3 MODOS FLASH

LED 12V FLASH 24V FLASH IMÁN R65 R10 IP67

AVFF.00055 DESTELLANTE LED CONEXION MASTIL FLEX. 12V / 24V 3 MODOS FLASH

LED 12V FLASH 24V FLASH R65 R10 IP67

AVFF.00056 DESTELLANTE LED IMÁN+CABLE 12V/24V 3 MODOS FLASH

LED FLASH FLASH IMÁN R10 R65 IP67

AVFF.00057 DESTELLANTE LED CONEXION MASTIL FLEX. 12V / 24V 3 MODOS FLASH

LED FLASH FLASH R10 R65 IP67

LED **12V** **24V** **FLASH** **FLASH** **IMAN** **R65** **R10** **IP67** **AVFF.00060**
 DESTELLANTE LED
 IMAN+CABLE
 12V/24V

E



LED **12V** **24V** **FLASH** **FLASH** **R65** **R10** **IP67** **AVFF.00061**
 DESTELLANTE LED
 MONTAJE MASTIL FLEX
 12V/24V

E



LED **12V** **24V** **IMAN** **R10** **R65** **IP67** **AVFF.00068**
 ROTATIVO/FLASH
 LED MULTIFUNCIÓN
 12V/24V

E

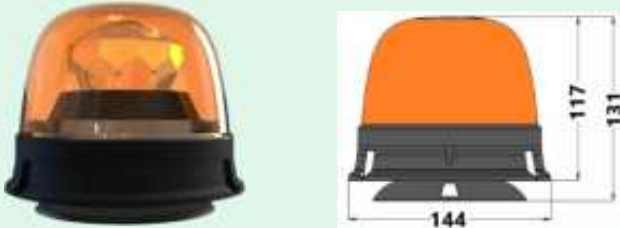

LED **12V** **24V** **R10** **R65** **IP67** **AVFF.00069**
 ROTATIVO/FLASH LED
 MONTAJE MASTIL FLEX
 12V/24V

E



LED **12V** **24V** **FLASH** **FLASH** **R65** **R10** **IP67** **AVFO.03021**
 DESTELLANTE LED
 MONTAJE MASTIL FLEX
 12V/24V

E



LED **12V** **24V** **FLASH** **FLASH** **R65** **R10** **IP67** **AVFO.03022**
 DESTELLANTE LED
 MONTAJE FIJFO
 12V/24V

E



LED **12V** **24V** **FLASH** **FLASH** **IMAN** **R65** **R10** **IP67** **AVFO.03023**
 DESTELLANTE LED
 IMAN+CABLE
 12V/24V

E



LED **12V** **24V** **IMAN** **R10** **R65** **IP67** **AVFO.03024**
 MULTIFUNCIÓN
 ROTATIVO / FLASH
 IMAN+CABLE
 12V / 24V

E



LED **12V** **24V** **FLASH** **FLASH** **R10** **R65** **IP67** **AVFO.03025**
 MULTIFUNCIÓN LED
 ROTATIVO / FLASH
 MONTAJE FIJO
 12V/24V

E



LED **12V** **24V** **R10** **R65** **IP67** **AVFO.03026**
 DESTELLANTE LED
 CONEXIÓN MASTIL FLEX.
 12V / 24V
 3 MODOS FLASH

E



LED **FLASH** **FLASH** **IMAN** **R10** **IP67** **AVPH.05711R**
 DESTELLANTE LED
 ROJO IMAN+CABLE
 12V/24V

92
130

LED **FLASH** **FLASH** **IMAN** **R10** **R65** **IP67** **AVPH.05711V**
 DESTELLANTE LED
 MONTAJE MASTIL FLEX
 12V/24V

92
130

LED **FLASH** **FLASH** **IMAN** **R10** **R65** **IP67** **AVPH.35572A**
 ROTATIVO/FLASH
 LED MULTIFUNCIÓN
 12V/24V

56,5mm
111mm

LED **12V** **FLASH** **24V** **FLASH** **IMAN** **R65** **R10** **IP67** **AVPH.35572AZ**
 DESTELLANTE LED
 IMAN+CABLE
 12V/24V

56,5mm
111mm

LED **70-170V** **FLASH** **IMAN** **R10** **AVFF.00022**
 DESTELLANTE LED
 MONTAJE FIJO
 ESPECIAL CARRETILLAS
 12V/24V

130mm
100mm

LED **70-170V** **FLASH** **IMAN** **R10** **R65** **AVFF.35009**
 DESTELLANTE LED
 IMAN+CABLE
 12V/24V

130mm

LED **V16** **FLASH** **IP67** **IMAN** **USB** **AVFF.35053**
 BALIZA S.O.S. V16
 E9 9C19070380
 CARGA USB
 CABLE USB INCLUIDO

69mm
53mm

LED **12V** **FLASH** **24V** **FLASH** **IMAN** **R65** **R10** **IP67** **AVFF.00044**
 DESTELLANTE PLANO
 IMAN+CABLE
 12V / 24V

110,2
102,6
66,6

LED **BATERIA** **IMAN** **R10** **R65** **IP67** **USB** **AVPH.35208**
 MULTIFUNCIÓN LED
 BATERIA LI-ION
 ROTATIVO / FLASH
 CON MANDO A DISTANCIA / IMAN+CABLE USB

80mm
136mm
Li-ion Battery

LED **12V** **24V** **FLASH** **FLASH** **IMAN** **R65** **R10** **IP67** **AVFF.00015**

**DESTELLANTE LED
IMAN+CABLE
12V/24V**

E



LED **12V** **24V** **FLASH** **FLASH** **R65** **R10** **IP67** **AVFF.00409**

**DESTELLANTE LED
MONTAJE FIJO
12V/24V**

E

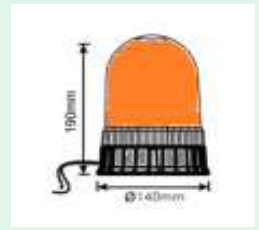

LED **12V** **24V** **FLASH** **R65** **R10** **IP67** **AVFF.W0051**

**DESTELLANTE LED
MONTAJE FIJO
10/110V**

E

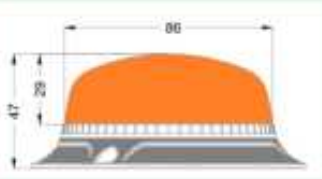

LED **12V** **24V** **FLASH** **FLASH** **R65** **R10** **IP67** **AVFF.00200**

**DESTELLANTE LED
MONTAJE MASTIL FLEX
12V/24V**

E

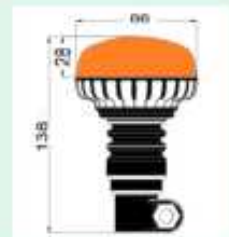

LED **12V** **24V** **FLASH** **FLASH** **IMAN** **R65** **R10** **IP67** **AVFF.00201**

**DESTELLANTE LED
MAGNETICO IMAN+CABLE
12V/24V**

E

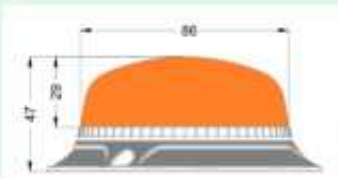

LED **12V** **24V** **FLASH** **FLASH** **R65** **R10** **IP67** **AVFF.00202**

**DESTELLANTE LED
MONTAJE FIJFO M10
12V/24V**

E



LED **12V** **24V** **FLASH** **FLASH** **R65** **R10** **IP67** **AVFF.00203**

**DESTELLANTE LED
MONTAJE FIJO
12V/24V**

E

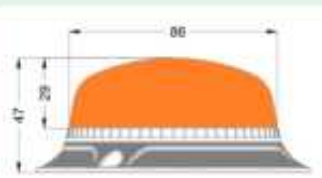



AVFF.35542 AZUL O AMBAR

MALETIN BALIZAS EMERGENCIA 6 PCS
AUTOSINCRONIZADAS 9 MODOS FLASH & SOS
POSIBILIDAD DE SINCRONIZAR HASTA 16PCS
CARGADOR INCLUIDO 220V & ENCENDEDOR 12V/24V.

E



AVFF.00002

PUENTE LED
DESTELLANTE IMAN+CABLE
12V/24V

E

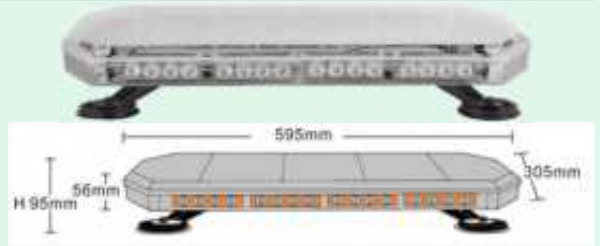

AVFF.00010

MINI PUENTE LED
DESTELLANTE
12V/24V / IMAN+CABLE

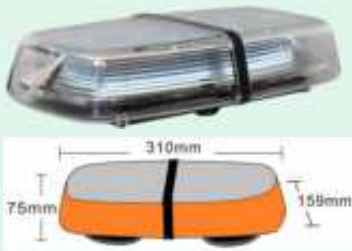

AVFF.00031

MINI PUENTE LED
DESTELLANTE
12V/24V / IMAN+CABLE

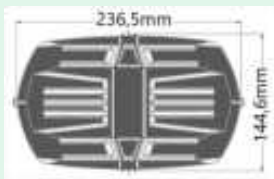

AVFF.00320

MINI PUENTE LED
DESTELLANTE
12V/24V IMAN+CABLE

E



AVFF.00330

MINI PUENTE LED
MONTAJE FIJFO
12V/24V

E



AVFF.00044

BARRA LED
DESTELLANTE 3-MODOS C/MANDO
MONTAJE FIJO C/CABLE
12V/24V

E



AVFF.00036

BARRA LED
DESTELLANTE 6-MODOS FLASH
MONTAJE FIJO C/CABLE
12V/24V

E



AVFF.00037

BARRA LED
DESTELLANTE 6-MODOS FLASH
MONTAJE FIJO C/CABLE
12V/24V

E



AVFF.00038

BARRA LED
DESTELLANTE 6-MODOS FLASH
MONTAJE FIJO C/CABLE
12V/24V

E

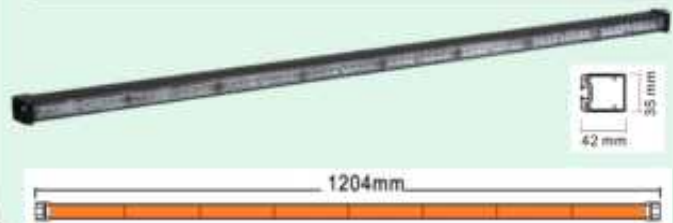

BARRAS DE EMERGENCIA DINAMICAS



DINAMICO AMBOS LADOS

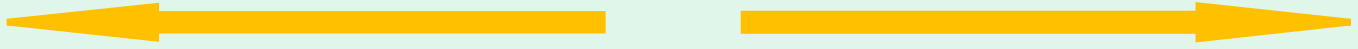

DINAMICO IZQUIERDA



DINAMICO DERECHA

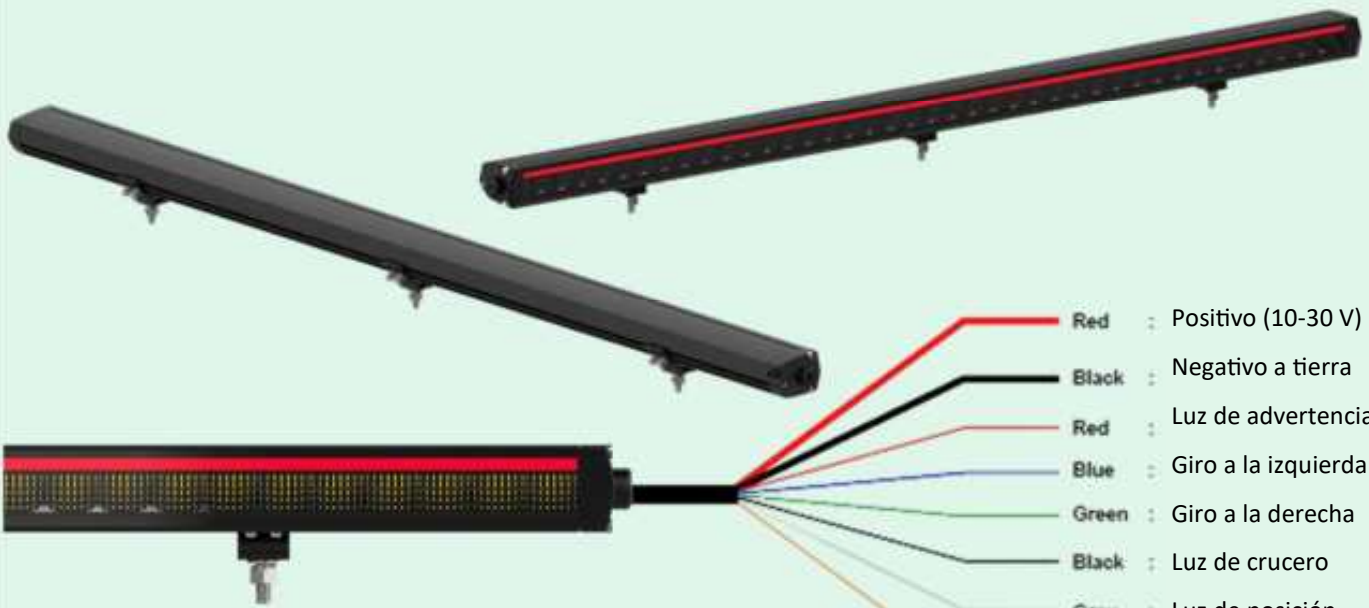

- Red : Positivo (10-30 V)
- Black : Negativo a tierra
- Red : Luz de advertencia
- Blue : Giro a la izquierda
- Green : Giro a la derecha
- Black : Luz de cruceo
- Grey : Luz de posición
- Yellow : Cambio función flash

REFERENCIA	LED	DIMENSIONES mm	DIMENSIONES INCH	WATIOS	ESPECIFICACIONES
AVPH.L5-30	30	820mm	32.3 INCH	60W	Luz de advertencia ámbar 14 modos de funcionamiento Con luz de posición trasera (roja) Con giro a la izquierda/derecha y flecha hacia afuera ECE 65 XT2, R10 SAE J595 Clase 1 Cables de 8 hilos Cable de 1 metro Soporte lateral + soporte central 10-30 V IP67 a prueba de agua Carcasa de aleación de aluminio Lente de policarbonato
AVPH.L5-40	40	1080mm	42.5 INCH	80W	
AVPH.L5-48	48	1280mm	50.4 INCH	96W	
AVPH.L5-56	56	1430mm	56.3 INCH	112W	



PUENTES LUMINOSOS DE EMERGENCIA DUAL COLOR



Módulos reemplazables en caso de avería.

Sensor automático de luz

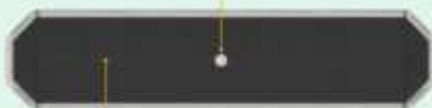

Carcasa de aluminio

Controla las luces flash en 4 direcciones diferentes

Controla las luces de trabajo en 4 direcciones diferentes



Ajustar el brillo al 50%	50%
Detecta automáticamente el día o la noche y ajusta automáticamente el brillo al 100 % durante el día y 50% por la noche	Auto Sensor
Apagar la visualización de la pantalla	Indicator
Mantenga las luces de advertencia en modo de encendido constante	Cruise Light
Todos los patrones de flash se mezclan y siguen cambiando cada cinco ciclos.	Random
Puede personalizar su modo favorito o más utilizado.	Favorite Pattern
Aviso de trafico, marca dirección hacia la izquierda	Left
Aviso de trafico, marca direcciones a ambos lados	Traffic Advisor
Aviso de trafico, marca dirección hacia la derecha	Right

REFERENCIA	MODULOS	DIMENSIONES	Nº LEDS DUAL COLOR	Nº LEDS TRABAJO	MODOS FLASH
AVPH.L3760	8	760MM	132pcs 2W LED (color 1) 132pcs 2W LED (color 2)	100pcs 0.5W White LED	Color 1: 10 MODOS Color 2: 10 MODOS MIX: 10 MODOS (flash alternativo)
AVPH.L31080	12	1080mm	180pcs 2W LED (color 1) 180pcs 2W LED (color 2)	180pcs 0.5W White LED	
AVPH.L31240	14	1240mm	204pcs 2W LED (color 1) 204pcs 2W LED (color 2)	204pcs 0.5W White LED	
AVPH.L31400	16	1400mm	228pcs 2W LED (color 1) 228pcs 2W LED (color 2)	228pcs 0.5W White LED	



ENLACE A VIDEO YOUTUBE



LED 12V FLASH 24V FLASH R65 R10 IP67 E



AVFF.00040
PUENTE LUMINOSO LED AMBAR
776mm / 12V24V
CON MANDO

AVFF.00041
PUENTE LUMINOSO LED AMBAR
1071mm / 12V24V
CON MANDO

AVFF.00042
PUENTE LUMINOSO LED AMBAR
1223mm / 12V24V
CON MANDO

AVFF.00043
PUENTE LUMINOSO LED AMBAR
1528mm / 12V24V
CON MANDO

LED 12V FLASH 24V FLASH R65 R10 IP67 **AVFF.00340**
PUENTE 1002mm
MONTAJE FIJO C/CABLE Y CONECTOR MECHERO
12V/24V 4 MODOS FLASH + MODO DIA/NOCHE

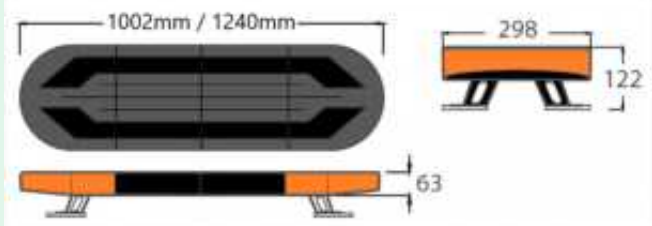

AVFF.00035
PUENTE 1240mm
MONTAJE FIJO C/CABLE Y CONECTOR MECHERO
12V/24V 4 MODOS FLASH + MODO DIA/NOCHE



LED 12V FLASH 24V FLASH R65 R10 IP67 E



AVFF.00008
PUENTE LUMINOSO LED AMBAR
1175mm / 12V24V
8 MODOS FLASH

***AVFF.00008A**
PUENTE LUMINOSO LED AZUL
1175mm / 12V24V
8 MODOS FLASH

***AVFF.00009A**
PUENTE LUMINOSO LED AZUL
1475mm / 12V24V
8 MODOS FLASH

*** HASTA AGOTAR
EXSISTENCIAS.**

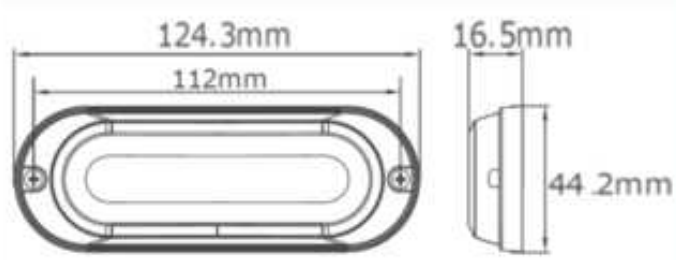

R65 R10 IP67

LED D.R.L. 12V FLASH 24V FLASH **AVFF.00046**
DESTELLANTE + PILOTO DRL
CABLE 200mm

LED 12V FLASH 24V FLASH **AVFF.00047**
DESTELLANTE + PILOTO
INTERMITENTE
CABLE 200mm

LED 12V FLASH 24V FLASH **AVFF.00048**
DESTELLANTE + PILOTO
POSICION + FRENO
CABLE 200mm

LED 12V FLASH 24V FLASH **AVFF.00049**
DESTELLANTE + GALIBO
LAT. AMBAR
CABLE 200mm

LED 12V FLASH 24V FLASH **AVFF.00050**
DESTELLANTE + PILOTO
MARCHA ATRAS
CABLE 200mm







AV.35.0210
AV.35.0211

DESTELLANTE ESTROBOSCOPICA









AV.35.0212
AV.35.0213

DESTELLANTE ESTROBOSCOPICA









AVFF.00285
DESTELLANTE LUZ ESTROBOSCOPICA SINCRONIZABLE
CABLE 200mm









AVFF.00298
DESTELLANTE LUZ ESTROBOSCOPICA SINCRONIZABLE
CABLE 200mm









AVFF.00025
DESTELLANTE LUZ ESTROBOSCOPICA SINCRONIZABLE
CABLE 200mm









AVFF.00032
DESTELLANTE LUZ ESTROBOSCOPICA SINCRONIZABLE
CABLE 200mm









AVFF.W0042
DESTELLANTE LUZ ESTROBOSCOPICA SINCRONIZABLE
CABLE 200mm









AVFF.W0043
DESTELLANTE LUZ ESTROBOSCOPICA SINCRONIZABLE
CABLE 200mm









AVFF.W0035
DESTELLANTE AZUL LUZ ESTROBOSCOPICA
DESTELLANTE 6 MODOS FLASH
CABLE 200mm 12V/24V









AVFF.W0034
LUZ ESTROBOSCOPICA AZUL DESTELLANTE SINCRONIZABLE 4 LEDS
CABLE 200mm 12/24V



LED SPOT IP67 E

AVFF.05416
BARRA LED + POSICIÓN LARGA DISTANCIA

-12V/24V
-18+30 LED'S
-45W+5W
-4000Lm

-CONEXIÓN CABLE

-HOMOLOGADA PARA CIRCULACIÓN POR CARRTERA

ECE R7-R10-R112

LED SPOT IP67 E

AVFF.05421
BARRA LED + DRL LARGA DISTANCIA

-12V/24V
-10+36 LED'S
-65W+10W
-5730Lm

-CONECTOR DT

-HOMOLOGADA PARA CIRCULACIÓN POR CARRTERA

ECE R10-R148-R149

LED SPOT IP67 E

AVFF.05423
BARRA LED + POSICIÓN LARGA DISTANCIA

-12V/24V
-62 LED'S
-8W+55W
-4925Lm

-CONECTOR DT

-HOMOLOGADA PARA CIRCULACIÓN POR CARRTERA

ECE R7-R10-R112

LED SPOT IP67 E

AVFF.05424
BARRA LED + POSICIÓN LARGA DISTANCIA

-12V/24V
-6+21 LED'S
-8W+42W
-3810Lm

-CONECTOR DT

-HOMOLOGADA PARA CIRCULACIÓN POR CARRTERA

ECE R10-R148-R149

LED SPOT IP67 E

AVFF.05425
BARRA LED + POSICIÓN LARGA DISTANCIA

-12V/24V
-12+24 LED'S
-5W+45W
-4708Lm

-CONECTOR DT

-HOMOLOGADA PARA CIRCULACIÓN POR CARRTERA

R10-R148-R149

LED SPOT D.R.L. IP67 E

AVFF.05417
BARRA LED + DRL LARGA DISTANCIA

-12V/24V
-6+3 LED'S
-3W+20W
-1570Lm

-CONEXIÓN CABLE

-HOMOLOGADA PARA CIRCULACIÓN POR CARRTERA

R10-R149-R148

LED SPOT D.R.L. IP67 E

AVFF.05418
BARRA LED + DRL LARGA DISTANCIA

-12V/24V
-6+12 LED'S
-3W+47W
-3340Lm

-CONEXIÓN CABLE

-HOMOLOGADA PARA CIRCULACIÓN POR CARRTERA

R10-R148-R149

LED SPOT IP67 E

AVFF.05422
FARO LED + POSICIÓN LARGA DISTANCIA

-12V/24V
-6+6 LED'S
-3W+25W
-2200Lm

-CONEXIÓN CABLE

-HOMOLOGADA PARA CIRCULACIÓN POR CARRTERA

R10-R148-R149

LED SPOT IP67 E

AVFF.05050
FARO LED LARGA DISTANCIA

-12V/24V
-6 LED'S
-16W
-1250Lm

-CONEXIÓN CABLE

-HOMOLOGADA PARA CIRCULACIÓN POR CARRTERA

R10-R112

LED SPOT IP67 E

AVFF.05420
FARO LED LARGA DISTANCIA

-12V/24V
-2 LED'S
-24W
-1750Lm

-CONEXIÓN CABLE

-HOMOLOGADA PARA CIRCULACIÓN POR CARRTERA

R10-R149



AVFF.05442
FARO LARGO ALCANCE LED
 78 LEDS 100W + 5W + 10W
 LUZ LARGA / POSICIÓN E INTERMITENTE DINAMICO&FLASH
 R10/R65/R148/R149 IP69K

LED, H, D, IP67

novedad!



AVFF.05443
FARO LARGO ALCANCE LED
 80 LEDS 80W + 5W + 10W
 LUZ LARGA / POSICIÓN E INTERMITENTE DINAMICO&FLASH
 R10/R65/R148/R149 IP69K

LED, H, D, IP67

novedad!



AVFF.05441
FARO LARGO ALCANCE LED
 108 LEDS 80W + 4W + 16W
 LUZ LARGA / POSICIÓN E INTERMITENTE DINAMICO&FLASH
 R10/R65/R148/R149 IP69K

LED, H, D, IP67

novedad!



AVPH.05432
FARO L.A. LED 60W 7500Lm 12V/24V IP67
 E9 R112
 CONECTOR DT

LED, H, D, IP67

novedad!





AVPH.05432B
FARO L.A. LED 60W 7500Lm 12V/24V IP67
 VERSIÓN FUME
 E9 R112
 CONECTOR DT

LED, H, D, IP67

novedad!



AVFF.05076B
 PANEL 60 LED'S
 12V/24V 90W 3900Lm
 CONEXIÓN CABLE 200mm

LED IP67 R10



65mm 308mm



AVFF.05077B
 PANEL 78 LED'S
 12V/24V 108W 4600Lm
 CONEXIÓN CABLE 200mm

LED IP67 R10



65mm 378mm



AVFF.05078B
 PANEL 84 LED'S
 12V/24V 126W 5460Lm
 CONEXIÓN CABLE 200mm

LED IP67 R10



65mm 448mm



AVFF.05079B
 PANEL 96 LED'S
 12V/24V 144W 6445Lm
 CONEXIÓN CABLE 200mm

LED IP67 R10



65mm 517mm



AVFF.05080
 PANEL 108 LED'S
 12V/24V 162W 7020Lm
 CONEXIÓN CABLE 200mm

LED IP67 R10



65mm 587mm



AVFF.05081
 PANEL 120 LED'S
 12V/24V 180W 7800Lm
 CONEXIÓN CABLE 200mm

LED IP67 R10



65mm 656mm



AVFF.05082
 PANEL 132 LED'S
 12V/24V 198W 8580Lm
 CONEXIÓN CABLE 200mm

LED IP67 R10



65mm 725mm



AVFF.05083
 PANEL 144 LED'S
 12V/24V 216W 9360Lm
 CONEXIÓN CABLE 200mm

LED IP67 R10



65mm 795mm



AVFF.05084
 PANEL 156 LED'S
 12V/24V 234W 10140Lm
 CONEXIÓN CABLE 200mm

LED IP67 R10



65mm 864mm



AVFF.05085
 PANEL 168 LED'S
 12V/24V 252W 10920Lm
 CONEXIÓN CABLE 200mm

LED IP67 R10



65mm 934mm



AVFF.05006
 PANEL 80 LED'S
 12V/24V 240W 7723Lm
 CONEXIÓN CABLE 200mm



1057mm
 1118mm
 122mm
 88mm

AVFF.05006V
 PANEL 80 LED'S CURVO
 12V/24V 108W 8000Lm
 CONEXIÓN CABLE 200mm



1060mm
 1087mm
 122mm
 88mm

AVFF.05005
 PANEL 60 LED'S
 12V/24V 180W 6527Lm
 CONEXIÓN CABLE 200mm



805mm
 866mm
 122mm
 88mm

AVFF.05005V
 PANEL 60 LED'S CURVO
 12V/24V 180W 6700Lm
 CONEXIÓN CABLE 200mm



805mm
 845mm
 122mm
 88mm

AVFF.05004
 PANEL 40 LED'S
 12V/24V 120W 4453Lm
 CONEXIÓN CABLE 200mm



550mm
 597mm
 122mm
 88mm

AVFF.05004V
 PANEL 40 LED'S CURVO
 12V/24V 120W 4964Lm
 CONEXIÓN CABLE 200mm



550mm
 591mm
 122mm
 88mm

AVFF.05027
 PANEL 40 LED'S
 12V/24V 120W 2434Lm
 CONEXIÓN CABLE 200mm



535mm
 609,2mm
 86,5mm
 114mm
 78,4mm

AVFF.05028
 PANEL 60 LED'S
 12V/24V 180W 3472Lm
 CONEXIÓN CABLE 200mm



790mm
 864,2mm
 86,5mm
 114mm
 78,4mm

AVFF.05030
 PANEL 100 LED'S
 12V/24V 300W 8650Lm
 CONEXIÓN CABLE 200mm



1318mm
 1393,2mm
 86,5mm
 114mm
 78,4mm

AVFF.05007
 PANEL 96 LED'S
 12V/24V 288W 8300Lm
 CONEXIÓN CABLE 200mm



1257mm
 1318mm
 122mm
 88mm

LED **IP67** **R10**

AVFF.05031
 PANEL 6LED'S
 12V/24V 14W 720Lm
 CONEXIÓN CABLE 200mm

E



LED **IP67** **R10**

AVFF.05032
 PANEL 12 LED'S
 12V/24V 24W 1200Lm
 CONEXIÓN CABLE 200mm

E



LED **IP67** **R10**

AVFF.05033
 PANEL 24 LED'S
 12V/24V 54W 2900Lm
 CONEXIÓN CABLE 200mm

E



LED **IP67** **R10**

AVFF.05034
 PANEL 42 LED'S
 12V/24V 93W 5000Lm
 CONEXIÓN CABLE 200mm

E



LED **IP67** **R10**

AVFF.05007V
 PANEL CURVO 96 LED'S
 12V/24V 288W 8584Lm
 CONEXIÓN CABLE 200mm

E



LED **IP67** **R10**

AVFF.05136
 PANEL 96 LED'S
 12V/24V 197W 11500Lm
 CONEXIÓN CABLE 200mm

E



LED **IP67** **R10**

AVFF.05043
 PANEL 24 LED'S
 12V/24V 72W 3767Lm
 CONEXIÓN CABLE 200mm

E



LED **IP67** **R10**

AVFF.05044
 PANEL 36 LED'S
 12V/24V 108W 5032Lm
 CONEXIÓN CABLE 200mm

E



LED **IP67** **R10**

AVFF.05045
 PANEL 48 LED'S
 12V/24V 144W 6473Lm
 CONEXIÓN CABLE 200mm

E



LED **IP67** **R10**

AVFF.05046
 PANEL 60 LED'S
 12V/24V 180W 7056Lm
 CONEXIÓN CABLE 200mm

E



LED **TRABAJO** **IP69K** **R10** **AVPH.WL64R**
 FARO TRABAJO 4 LED'S
 12V/24V 20W 1770Lm
 Ø80mm



novedad!
CON CONECTOR DEUTSCH

LED **TRABAJO** **IP69K** **R10** **AVPH.WL64S**
 FARO TRABAJO 4 LED'S
 12V/24V 20W 1770Lm
 70*70mm



novedad!
CON CONECTOR DEUTSCH

LED **TRABAJO** **IP69K** **R10** **AVPH.WL646**
 FARO TRABAJO 6 LED'S
 12V/24V 30W 2730Lm
 100*70mm



novedad!
CON CONECTOR DEUTSCH

LED **TRABAJO** **IP69K** **R10** **AVPH.WL6415**
 FARO TRABAJO 15 LED'S
 12V/24V 90W 8500Lm
 150*93mm



novedad!
LED TIPO OSRAM
CON CONECTOR DEUTSCH

LED **TRABAJO** **IP69K** **R10** **AVPH.05115/20**
 FARO TRABAJO 2 LED'S
 12V/24V 20W 2100Lm
 CONEXION CABLE 200mm



novedad!

LED **TRABAJO** **IP69K** **R10** **AVPH.05115/40**
 FARO TRABAJO 4 LED'S
 12V/24V 40W 4200Lm
 CONEXION CABLE 200mm



novedad!

LED **TRABAJO** **IP69K** **R10** **AVPH.05293F**
 FARO TRABAJO 4 LED'S
 12V/24V 40W 4800Lm
 SOPORTE 360° CONEXION CABLE 200mm 110*120mm



novedad!
LED TIPO OSRAM

LED **TRABAJO** **IP69K** **R10** **AVPH.05041**
 FARO TRABAJO 14 LED'S
 12V/24V 42W 2800Lm
 CONEXION CABLE 200mm 90°



novedad!
LED TIPO OSRAM

LED **TRABAJO** **IP69K** **R10** **AVPH.05042**
 FARO TRABAJO 16 LED'S
 12V/24V 48W 3000Lm
 CONEXION CABLE 200mm 84*84mm



novedad!
LED TIPO OSRAM

LED **TRABAJO** **IP67** **R10** **AVFF.02500**
 FARO MARCHA ATRÁS 9 LED'S
 12V/24V 10+4W 900/1200Lm
 CONEXION CABLE 200mm 127*100mm
 CON LUZ ESTROBOSCOPICA R65 R 148



novedad!

LED **TRABAJO** **IP67** **R10**

AVFF.05156
FARO TRABAJO 30 LED'S
 12V/24V 30W 2875Lm
 CONEXIÓN CABLE 200mm

E

CON INTERRUPTOR



LED **TRABAJO** **IP67** **R10**

AVFF.05154
FARO TRABAJO 16 LED'S
 12V/24V 16W 1844Lm
 CONEXIÓN CABLE 200mm

E

CON INTERRUPTOR



LED **TRABAJO** **IP67** **R10**

AVFF.05152
FARO TRABAJO 12 LED'S
 12V/24V 12W 1800Lm
 CONEXIÓN CABLE 200mm

E

CON INTERRUPTOR



LED **TRABAJO** **IP67** **R10**

AVFF.05167
FARO TRABAJO 10 LED'S
 12V/24V 15W 1600Lm
 CONEXIÓN CABLE 200mm

E



LED **TRABAJO** **IP67** **R10**

AVFF.05169
FARO TRABAJO 18 LED'S
 12V/24V 27W 2008Lm
 CONEXIÓN CABLE 200mm

E

CON INTERRUPTOR



LED **TRABAJO** **IP67** **R10**

AVFF.05166
FARO TRABAJO 16 LED'S
 12V/24V 24W 1732Lm
 CONEXIÓN CABLE 200mm

E



LED **TRABAJO** **IP67** **R10**

AVFF.05168
FARO TRABAJO 13 LED'S
 12V/24V 19W 1269Lm
 CONEXIÓN CABLE 200mm

E



LED **TRABAJO** **IP67** **R10**

AVFF.05153
FARO TRABAJO 12 LED'S
 12V/24V 12W 1311Lm
 CONEXIÓN CABLE 200mm

E

CON INTERRUPTOR



LED **TRABAJO** **IP67** **R10**

AVFF.05155
FARO TRABAJO 16 LED'S
 12V/24V 18W 1800Lm
 CONEXIÓN CABLE 200mm

E

CON INTERRUPTOR



LED **TRABAJO** **IP67** **R10**

AVFF.05157
FARO TRABAJO 24 LED'S
 12V/24V 24W 2907Lm
 CONEXIÓN CABLE 200mm

E

CON INTERRUPTOR



FAROS DE TRABAJO LED

LED **TRABAJO** **IP69K** **R10**

AVFF.05173
 FARO TRABAJO 18 LED'S
 12V/24V 26W 2800Lm
 CONEXIÓN CABLE 200mm

E



CON CONECTOR DEUTSCH



102mm, 40mm, 125.2mm, 116mm

LED **TRABAJO** **IP69K** **R10**

AVPH.05204
 FARO TRABAJO 16 LED'S
 12V/24V 80W(5W) 6400Lm
 CONEXIÓN CONECTOR

E



LED TIPO OSRAM

CON CONECTOR DEUTSCH



109mm, 57mm, 146mm, 109mm

LED **TRABAJO** **IP69K** **R10**

AVPH.05203
 FARO TRABAJO 9 LED'S
 12V/24V 45W(5W) 3600Lm
 CONEXIÓN CONECTOR

E



LED TIPO OSRAM

CON CONECTOR DEUTSCH



100mm, 48mm, 135mm, 53mm

LED **TRABAJO** **IP69K** **R10**

AVPH.05202
 FARO TRABAJO 9 LED'S
 12V/24V 45W(5W) 3600Lm
 CONEXIÓN CONECTOR

E



LED TIPO OSRAM

CON CONECTOR DEUTSCH



Φ105mm, 46mm, 136mm, 52mm

LED **TRABAJO** **IP69K** **R10**

AVPH.05208
 FARO TRABAJO 10 LED'S
 12V/24V 50W(5W) 9340Lm
 CONEXIÓN CONECTOR

E



LED TIPO OSRAM

CON CONECTOR DEUTSCH



177mm, 78mm, 179mm

LED **TRABAJO** **IP69K** **R10**

AVFF.05160
 FARO MARCH ATRAS 16 LED'S
 12V/24V 16W 1600Lm
 CONEXIÓN CABLE 200mm R23-R148

E



82mm, 41,8mm, 97,3mm

LED **TRABAJO** **IP69K** **R10**

AVPH.05001
 FARO TRABAJO 4 LED'S
 12V/24V 40W(10W) 3600Lm
 CONEXIÓN CONECTOR

HEAVY DUTY

E



LED TIPO CREE

CON CONECTOR DEUTSCH



97,6mm, 73,6mm, 117,6mm, 94,2mm

LED **TRABAJO** **IP69K** **R10**

AVPH.05002
 FARO TRABAJO 6 LED'S
 12V/24V 60W(10W) 5400Lm
 CONEXIÓN CONECTOR

HEAVY DUTY

E



LED TIPO CREE

CON CONECTOR DEUTSCH



131,1mm, 76,4mm, 117,9mm, 94,8mm

LED **TRABAJO** **IP69K** **R10**

AVPH.05003
 FARO TRABAJO 9 LED'S
 12V/24V 90W(10W) 8100Lm
 CONEXIÓN CONECTOR

HEAVY DUTY

E



LED TIPO CREE

CON CONECTOR DEUTSCH



133,6mm, 78,7mm, 151,4mm, 128,3mm

LED **TRABAJO** **IP69K** **R10**

AVPH.05004
 FARO TRABAJO 12 LED'S
 12V/24V 120W(10W) 10800Lm
 CONEXIÓN CONECTOR

HEAVY DUTY

E



LED TIPO CREE

CON CONECTOR DEUTSCH



167mm, 78,7mm, 151,5mm, 128,6mm

LED **SPOT** **IP67** **R10**

AVFF.05175
 FARO TRABAJO 4 LED'S
 12V/24V 12W 830Lm
 CONEXIÓN CABLE 200mm

E

LED **TRABAJO** **IP67** **R10**

AVFF.05068
 FARO TRABAJO 5 LED'S
 12V/24V 12W 830Lm
 CONEXIÓN CABLE 200mm

E

LED **TRABAJO** **IP67** **R10**

AVFF.05075
 FARO TRABAJO 4 LED'S
 12V/24V 20W 1600Lm
 CONEXIÓN CABLE 200mm

E

LED **TRABAJO** **IP67** **R10**

AVFF.05077
 FARO TRABAJO 9 LED'S
 12V/24V 24W 1430Lm
 CONEXIÓN CABLE 200mm

E

LED **TRABAJO** **IP67** **R10**

AVFF.05048
 FARO TRABAJO 16LED'S
 12V/24V 43W 2100Lm
 CONEXIÓN CABLE 200mm

E

LED **TRABAJO** **IP67** **R10**

AVFF.05099
 FARO TRABAJO 6 LED'S
 12V/24V 14,5W 1100Lm
 CONEXIÓN CABLE 200mm

E

LED **TRABAJO** **IP67** **R10**

AVFF.05097
 FARO TRABAJO 13 LED'S
 12V/24V 19W 1269Lm
 CONEXIÓN CABLE 200mm

E

LED **TRABAJO** **IP67** **R10**

AVFF.05180
 FARO TRABAJO 6LED'S
 12V/24V 18W 1200Lm
 CONEXIÓN CABLE 200mm

E

LED **TRABAJO** **IP67** **R10**

AVPH.05262
 FARO TRABAJO 12LED'S
 12V/24V 60W 5400Lm
 CONEXIÓN CONECTOR LAMP. H4

E

LED **TRABAJO** **IP67** **R10**

AVPH.05205
 FARO TRABAJO 30 LED'S
 12V/24V 45W 2700Lm
 CONEXIÓN CABLE 200mm

E

LED **TRABAJO** **IP67** **R10**

AVFF.05074
 FARO TRABAJO 4 LED'S
 12V/24V 16W 1100Lm
 CONEXIÓN CABLE 200mm

112mm 63mm
128mm

LED **TRABAJO** **IP67** **R10**

AVFF.05076
 PANEL 12 LED'S
 12V/24V 24W 1200Lm
 CONEXIÓN CABLE 200mm

115mm 45mm
128mm

LED **TRABAJO** **IP67** **R10**

AVFF.05078
 FARO TRABAJO 8 LED'S
 12V/24V 24W 1920Lm
 CONEXIÓN CABLE 200mm

140mm 55mm
86mm

LED **TRABAJO** **IP67** **R10**

AVFF.05105
 FARO TRABAJO 13 LED'S
 12V/24V 39W 2650Lm
 CONEXIÓN CABLE 200mm

144mm 89.4mm
124mm

LED **TRABAJO** **IP67** **R10**

AVPH.05213F
 FARO TRABAJO 6 LED'S
 10V-80V 45W 2800Lm
 CONEXIÓN CABLE 200mm

140mm 55mm
86mm

LED **TRABAJO** **IP67** **R10**

AVPH.05237F
 FARO TRABAJO 8 LED'S
 12V/24V 24W 2240Lm
 CONEXIÓN CABLE 200mm SUJECIÓN LATERAL

90mm 65mm
198mm

LED **SPOT** **IP67** **R10**

AVPH.05215F
 FARO TRABAJO 12 LED'S
 12V/24V 36W 1800Lm
 CONEXIÓN CABLE 200mm

CON INTERRUPTOR

230mm 230mm

LED **TRABAJO** **IP67** **R10**

AVPH.05215S
 FARO TRABAJO 12 LED'S
 12V/24V 36W 1800Lm
 CONEXIÓN CABLE 200mm

CON INTERRUPTOR

230mm 230mm

LED **TRABAJO** **IP67** **R10**

AVPH.05113R
 FARO TRABAJO 9 LED'S
 12V/24V 27W 2070Lm
 CONEXIÓN MASTIL

58mm 115mm 95mm

LED **TRABAJO** **IP67** **R10**

AVPH.052111
 FARO TRABAJO 9 LED'S AZUL
 12V/24V 27W 2500Lm
 CONEXIÓN CABLE 200mm ESPECIAL SULFATACIÓN

108mm 47mm
128mm

LED TRABAJO IP67 R10

AVPH.05021

FARO TRABAJO 30 LED'S
12V/24V 30W 2400Lm

CONEXIÓN CABLE 200mm / ASA DESMONTABLE

E



CON INTERRUPTOR

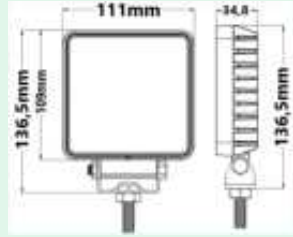

LED TRABAJO IP67 R10

AVPH.05022

FARO TRABAJO 24 LED'S
12V/24V 24W 1920Lm

CONEXIÓN CABLE 200mm / ASA DESMONTABLE

E

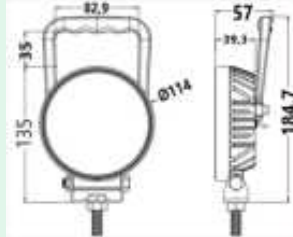

CON INTERRUPTOR



LED TRABAJO IP67 R10

05.2027.0000

FARO TRABAJO 3 LED'S
12V/24V 31W 2600Lm

CONEXIÓN CABLE 200mm

E COBO

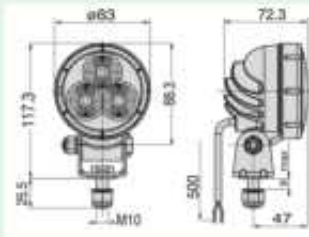

LED SPOT IP67 R10

05.2029.0000

FARO TRABAJO 3 LED'S
12V/24V 30W 2600Lm

CONEXIÓN CABLE 200mm

E COBO

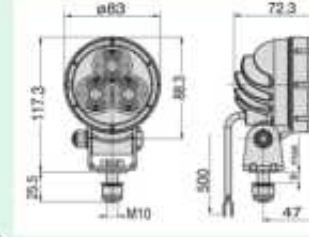

LED TRABAJO IP67 R10

AV.05.0056

FARO TRABAJO 4LED'S
10V-80V 12W 700Lm

CONEXIÓN CABLE 200mm

E COBO

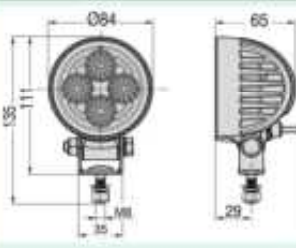

LED TRABAJO IP67 R10

05.2001.0000

FARO TRABAJO 10 LED'S
9V-60V 28W 2000Lm

CONEXIÓN CONECTOR DEUTSCH

E COBO

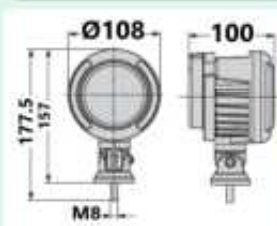

CON CONECTOR DEUTSCH



LED TRABAJO IP67 R10

05.1762.0000

FARO TRABAJO 10 LED'S
12V/24V 28W 2000Lm

CONEXIÓN CONECTOR DEUTSCH

E COBO



CON CONECTOR DEUTSCH

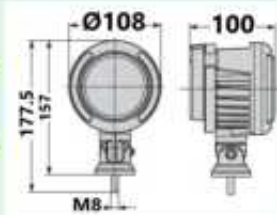

LED SPOT IP67 R10

05.1778.0000

FARO TRABAJO 10 LED'S
12V/24V 28W 2000Lm

CONEXIÓN CONECTOR DEUTSCH

E COBO

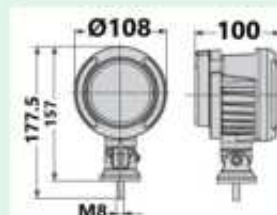

CON CONECTOR DEUTSCH



LED TRABAJO IP67 R10

AV.05.0042

FARO TRABAJO 6LED'S
12V/24V 18W 1500Lm

CONEXIÓN CABLE 500mm

E COBO

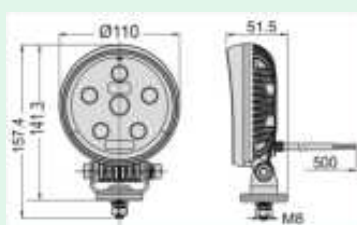

LED TRABAJO IP67 R10

AV.05.2014

FARO TRABAJO 6 LED'S
12V/24V 18W 1500Lm

CONEXIÓN MECHERO + IMAN

E COBO

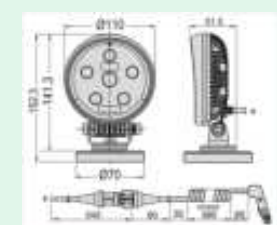

FAROS TRABAJO LED COBO

LED **TRABAJO** **IP67** **R10**

AV.05.0047
FARO TRABAJO 2LED'S
 12V/24V 6W 450Lm
 CONEXIÓN CABLE 500mm

E **COBO** **E**

LED **TRABAJO** **IP67** **R10**

AV.05.0048
PANEL 3 LED'S
 12V/24V 9W 750Lm
 CONEXIÓN CABLE 500mm

COBO **E**

LED **TRABAJO** **IP67** **R10**

05.1678.0000
FARO TRABAJO 8 LED'S
 12V/24V 24W 2000Lm
 CONEXIÓN CABLE 500mm

E **COBO** **E**

LED **TRABAJO** **IP67** **R10**

AV.05.0044
FARO TRABAJO 4 LED'S
 12V/24V 12W 800Lm
 CONEXIÓN CABLE 500mm

COBO **E**

LED **TRABAJO** **IP67** **R10**

AV.05.0043
FARO TRABAJO 5 LED'S
 12V/24V 15W 1250Lm
 CONEXIÓN CABLE 500mm

E **COBO** **E**

LED **TRABAJO** **IP67** **R10**

AV.05.0046
FARO TRABAJO 9 LED'S
 12V/24V 27W 2700Lm
 CONEXIÓN CABLE 500mm

COBO **E**

LED **TRABAJO** **IP67** **R10**

AV.05.0034.01
FARO TRABAJO 6 LED'S
 12V/24V 18W 1500Lm
 CONEXIÓN CABLE 500mm

E **COBO** **E**

LED **SPOT** **IP67** **R10**

AV.05.0036
FARO TRABAJO 6 LED'S
 12V/24V 18W 1380Lm
 CONEXIÓN CABLE 500mm

COBO **E**

LED **TRABAJO** **IP67** **R10**

05.1642.0000
FARO TRABAJO 10 LED'S
 12V/24V 30W 1600Lm
 CONEXIÓN CONECTOR SEAL

E **COBO** **E**

CONECTOR SEAL

LED **SPOT** **IP67** **R10**

05.1643.0000
FARO TRABAJO 9 LED'S
 12V/24V 30W 1600Lm
 CONEXIÓN CONECTOR SEAL

COBO **E**

CONECTOR SEAL

05.155.000
FARO TRABAJO
LAMPARA H3
EQUIPO ORIGINAL CNH

HALOGEN TRABAJO IP54

E COBO E

CON INTERRUPTOR



05.275.000
FARO TRABAJO
LAMPARA H3
EQUIPO ORIGINAL FIAT-SAME

HALOGEN TRABAJO IP54

E COBO E



05.299.000
FARO TRABAJO
LAMPARA H3
EQUIPO ORIGINAL KOMATSU

HALOGEN TRABAJO IP54

E COBO E



05.635.000(D) - 05.636.000(I)
FARO TRABAJO
LAMPARA H3
CONEXIÓN PASACABLE

HALOGEN TRABAJO IP54

E COBO E



05.643.000
FARO TRABAJO 5ª RUEDA
LAMPARA P21W
CONEXIÓN PASACABLE

HALOGEN TRABAJO IP54

E COBO E

CON INTERRUPTOR



05.1100.0000
FARO TRABAJO
LAMPARA H3
CONEXIÓN CONECTOR SEAL

HALOGEN TRABAJO IP54

E COBO E



05.1633.0000
FARO TRABAJO
LAMPARA H3
CRISTAL TEMPLADO

HALOGEN TRABAJO IP54

E COBO E



05.1190.0000
FARO TRABAJO SPOT
LAMPARA H3
CONEXIÓN CABLE

HALOGEN SPOT IP54

E COBO E



05.0698.0000.41
FARO TRABAJO
LAMPARA GE886 12V INCLUIDA
CONECTOR LAMP. GE886

HALOGEN SPOT IP54

E COBO E



05.0950.0000.13
FARO TRABAJO
LAMPARA GE886 12V INCLUIDA
CONECTOR LAMP. GE886

HALOGEN TRABAJO IP54

E COBO E



FAROS TRABAJO COBO

LED    **IP67**

AV.05.0053
FARO PUNTO AZUL
 10-80V 6W 120Lm
 CONEXIÓN CABLE 500mm

E 





LED    **IP67**

AV.05.0055
FARO PUNTO ROJO
 10-80V 6W 120Lm
 CONEXIÓN CABLE 500mm

 **E**





LED    **IP67**

AV.05.0054
FARO PUNTO ROJO
 10-80V 6W 180Lm
 CONEXIÓN CABLE 500mm

E 





LED    **IP67**

AVPH.05911A
FARO CARRETILLA
FLECHA AZUL
 10-80V 9W
 CONEXIÓN CABLE 500mm

E







LED    **IP67**

AVPH.05911R
FARO CARRETILLA
FLECHA ROJA
 10-80V 9W
 CONEXIÓN CABLE 500mm

E





LED    **IP67**

AVPH.05912A
FARO CARRETILLA
LINEA AZUL
 10-80V 9W
 CONEXIÓN CABLE 500mm

E



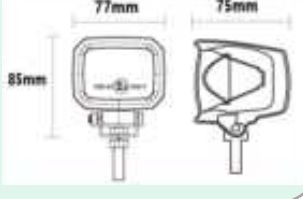

LED    **IP67**

AVPH.05912R
FARO CARRETILLA
LINEA ROJA
 10-80V 9W
 CONEXIÓN CABLE 500mm

E





LED    **IP67**

AVPH.05916A
FARO CARRETILLA
LINEA PERIMETRAL AZUL
 10-80V 20W
 CONEXIÓN CABLE

E





LED    **IP67**

AVPH.05916R
FARO CARRETILLA
LINEA PERIMETRAL ROJA
 10-80V 20W
 CONEXIÓN CABLE

E





L.M. IP54
E COBO E

02.212.000
LUZ MATRICULA
LAMPARA C5W
CONEXIÓN PASACABLES

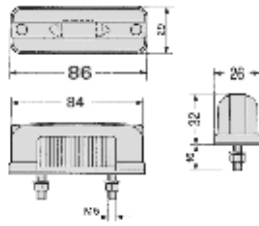

L.M. IP54
E COBO E

02.240.000
LUZ MATRICULA
LAMPARA C5W
CONEXIÓN PASACABLES

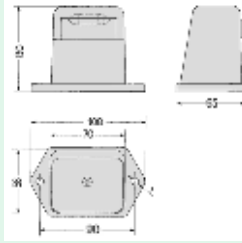

L.M. IP54
E COBO E

02.246.000
LUZ MATRICULA
LAMPARA C5W
CONEXIÓN PASACABLES

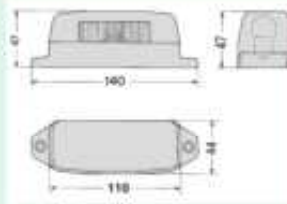

L.M. IP54
E COBO E

02.452.000
LUZ MATRICULA
LAMPARA C5W
CONEXIÓN CABLE+FASTON

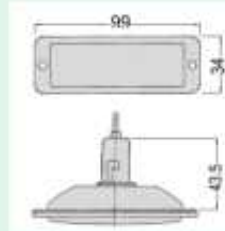

L.M. IP54
E COBO E

02.482.000(IZ)-02.483.000(D)
PILOTO MATRICULA
LAMPARA R5W
CONECTOR ROSCADO
EQUIPO OE IVECO 4817744(I)/4817918

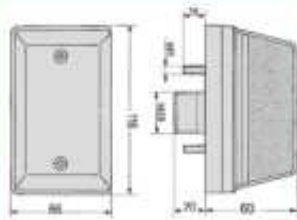

L.M. IP54
E COBO E

02.648.000(D)-02.649.000(I)
PILOTO MATRICULA
LAMPARA R5W
CONECTOR 27.0911.0000
EQUIPO OE IVECO 98462653 (D) / 94862654 (I)

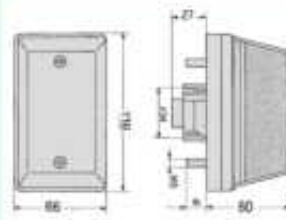

LED L.M. IP54
E COBO E

**02.1494.0000.41(12V)
02.1549.0000.42(24V)**
PILOTO MATRICULA LED
CONECTOR CABLE 500mm

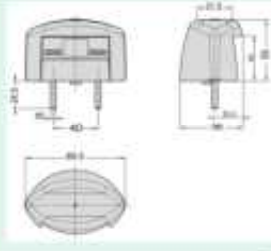

LED L.M. IP67
E COBO E

AV.02.0158
PILOTO MATRICULA LED
12V/24V
CONEXIÓN CABLE 250mm

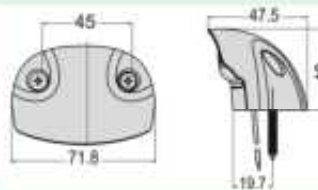

LED L.M. IP67
E COBO E

AV.02.0184
PILOTO MATRICULA LED
12V/24V
CONEXIÓN CABLE

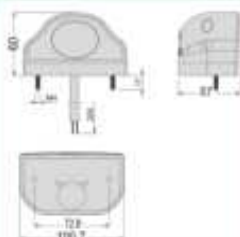

LED L.M. IP67
E COBO E

AV.02.0203
PILOTO MATRICULA LED
12V/24V
CONEXIÓN CABLE

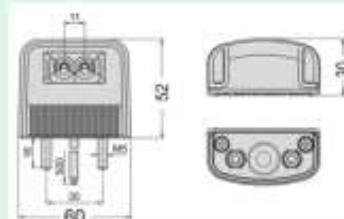

02.1056.0000
 LUZ MATRICULA
 LAMPARA T10 CONECTOR SEAL 27.0958.0000
 PORTALAMPARAS 30.12.06267

L.M. IP54

AVFF.02515
 PILOTO MATRICULA LED
 12V/24V
 CONEXIÓN CABLE

LED L.M. IP67

AVFF.02655
 PILOTO MATRICULA LED
 12V/24V
 CONEXIÓN CABLE

LED L.M. IP67

AVPH.00009
 CABLE ESPIRAL + CONECTOR MECHERO

AVFF.00622
 PRE-INSTALACIÓN CABLEADO FAROS
 12V 120W MAX 2.5MTS CABLES
 RELE 40A C/CONECTORES DT

AVPH.00043
 JGO. SOPORTE
 FAROS / BARRAS LED
 Ø44mm(1,75INCH) LARGO 65mm

AVPH.00038
 JGO. SOPORTE FAROS
 BARRAS LED
 Ø44mm(1,75INCH) LARGO 95mm

AVPH.00005
 IMAN UNIVERSAL
 PARA FAROS / BARRAS Y PANELES

AVPH.04407
 PILOTO PARA PLATAFORMA ELEVADORA
 12V/24V 2W LUZ AMBAR

36.0301
 SOPORTE MASTIL ROTATIVO
 ENTRADA RAPIDA
 FIJACION TORNILLOS

36.0302
 SOPORTE MASTIL ROTATIVO
 ENTRADA RAPIDA
 TIPO "L" FIJACIÓN TORNILLOS

36.0303
 SOPORTE MASTIL ROTATIVO
 ENTRADA RAPIDA
 FIJACIÓN MONOTUERCA

36.0304
 SOPORTE MASTIL ROTATIVO
 ENTRADA RAPIDA
 FIJACIÓN TORNILLOS

LED **R10**
AVFF.10879
 PLAFON INTERIOR LED
 C/ INTERRUPTOR Y REGULADOR INTENSIDAD 6000°K
 12V/24V CON LUZ DE CORTESIA LUZ CALIDA



E **LC-03500**
 PLAFON LED MINI
 Ø52mm 8-30V 1W 3200°K
 FIJACION TORNILLO +ADHESIVO



E **LC-02500**
 PLAFON LED MINI
 52X52X6mm 8-30V 1W 3200°K
 FIJACION TORNILLO +ADHESIVO



LED **IP67**
AV.10.0057
 PLAFÓN LUZ INTERIOR LED
 12V/24V
 CON INTERRUPTOR





LED **IP67**
AV.10.0109 CON INTERRUPTOR
 PLAFÓN INTERIOR LED 12V/24V
 FIJACIÓN TORNILLO 364LM 6000°K
 CONEX. CABLE



LED **IP67**
AV.10.0107
 PLAFÓN INTERIOR LED
 CONEXIÓN CABLE
 CON INTERRUPTOR



LED **IP67**
AV.10.0112
 PLAFÓN INTERIOR LED
 CONEXIÓN CABLE
 CON INTERRUPTOR

LED **IP67**
AV.10.0063.41 (12V)
AV.10.0063.42 (24V)
 PLAFÓN INTERIOR LED
 FIJACIÓN TORNILLO / CONEX. CABLE



LED **IP67**
AV.10.0064.41 (12V)
AV.10.0064.42 (24V)
 PLAFÓN INTERIOR LED
 FIJACIÓN TORNILLO / CONEX. CABLE



10.103.000 (165mm) **10.104.000 (120mm)**
 PLAFÓN INTERIOR
 LAMPARA C5W
 CON INTERRUPTOR



10.117.000
 LUZ ESCALERA IVECO OE
 LAMPARA R5W
 EQUIPO ORIGINAL IVECO 98462312



06.0255.0000
REFLEX TRASERO
EQUIPO ORIGINAL NEW HOLLAND
84321098 REF OE

06.0232.0000
REFLEX TRASERO
CON TORNILLO

06.192.000
REFLEX TRASERO
CON TORNILLO

06.207.000
REFLEX TRASERO
CON TORNILLO

06.189.000
REFLEX TRASERO
FIJACIÓN CON TORNILLOS
OE. LANDINI / MASSEY FERGUSON 3308241M92

AVFF.01760
AVFF.01761-1*
REFLEX AMBAR ADHESIVO
*CON AGUJERO

AVFF.01761
AVFF.01761-1*
REFLEX BLANCO ADHESIVO
*CON AGUJERO

AVFF.01762
AVFF.01762-1*
REFLEX ROJO ADHESIVO
*CON AGUJERO



AVFF.01752
REFLEX AMBAR
CON TORNILLO M5

AVFF.01751
REFLEX BLANCO
CON TORNILLO M5

AVFF.01753
REFLEX ROJO
CON TORNILLO M5

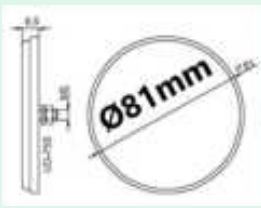

AVFF.01759
REFLEX AMBAR ADHESIVO

AVFF.01757
REFLEX BLANCO ADHESIVO

AVFF.01758
REFLEX ROJO ADHESIVO

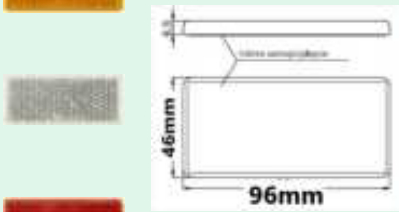

AVFF.01402
REFLEX AMBAR
ADHESIVO

AVFF.01401
REFLEX BLANCO
ADHESIVO

AVFF.01403
REFLEX ROJO
ADHESIVO

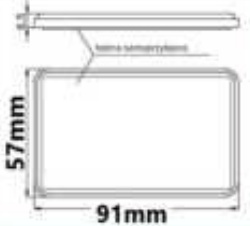

AVFF.01722
REFLEX AMBAR ADHESIVO

AVFF.01720
REFLEX BLANCO ADHESIVO

AVFF.01721
REFLEX ROJO ADHESIVO

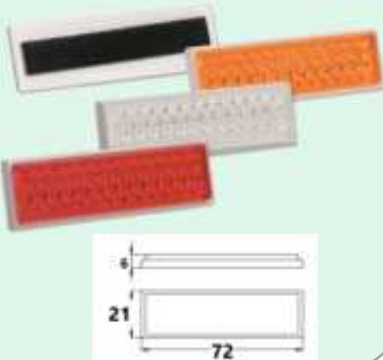

AVFF.01405
REFLEX TRASERO
REMOLQUE
CON AGUJEROS TORNILLOS

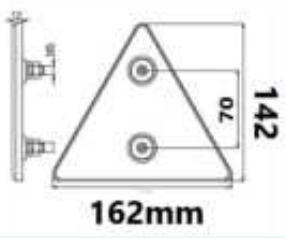



COBO

	09.451.000		09.456.000		09.468.000		09.858.000
	09.450.000		09.459.000		09.461.000		09.547.000
	09.454.000		09.500.000		09.472.000		09.458.000
	09.452.000		09.471.000		09.476.000		09.463.000
	09.460.000		09.457.000		09.486.000		09.462.000

	09.200.000		09.221.000		09.234.000
	09.209.000		09.260.000		09.216.000
	09.210.000		09.220.000		09.251.000
	09.211.000		09.222.000		09.284.000
	09.203.000		09.227.000		

COBO



AVFF.01063



AVFF.01064



AVFF.01065



AVFF.01066



Ø 16mm 12V LED 0.5W LUCES DE CONTROL

09.305.000

LUZ CONTROL TABLERO
RESERVA+TEMP. ACEITE

COBO

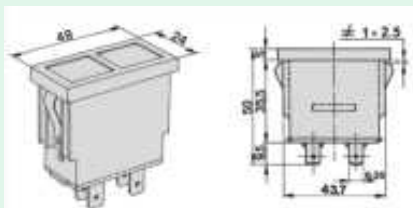

09.327.000

LUZ CONTROL TABLERO
PRESIÓN ACEITE+TEMP. AGUA

COBO

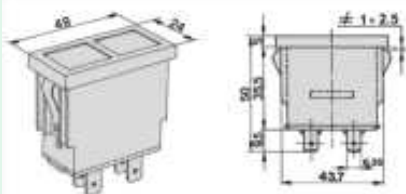

09.341.000

LUZ CONTROL TABLERO
FILTRO AIRE+BATERIA

COBO

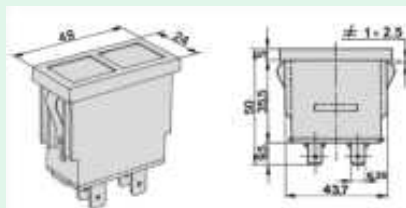

09.354.000

LUZ CONTROL TABLERO
BATERIA+FRENO ESTACIONAMIENTO

COBO

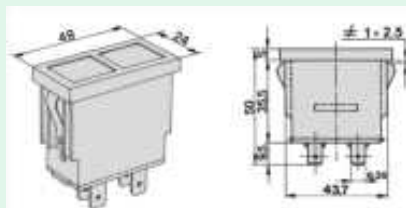

LUCES DE CONTROL

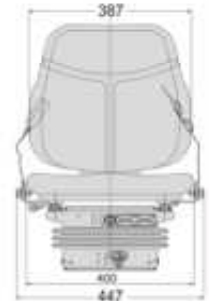
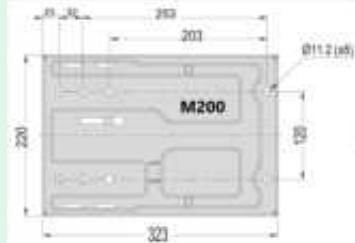
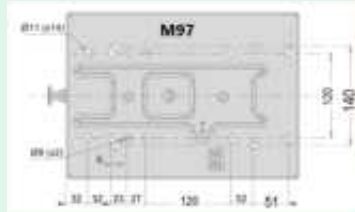

(MECANICO)SC74/M200 **E8091.491**
(NEUMATICO)SC74/M97 **E8091.492**

E

**ASIENTO COBO SC74
C/ CINTURÓN DE SEGURIDAD
SENSOR PRESENCIA
TAPIZADO SKY NEGRO**

(MECANICO)SC84/M200 **E8080.177**
(NEUMATICO)SC84/M97 **E8080.178**



**ASIENTO COBO SC84
C/ CINTURÓN DE SEGURIDAD
SENSOR PRESENCIA
TAPIZADO TELA GRIS**

E

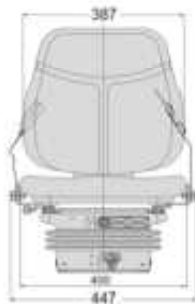
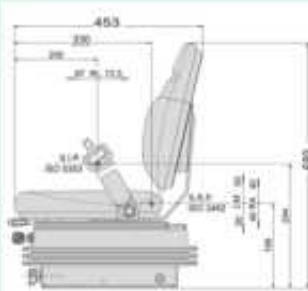
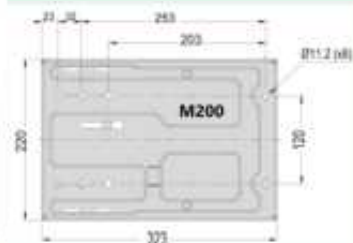

**PRODUCTO
BAJO PEDIDO**

(NEUMATICO)SR845/M97 **E8077.041**

E

**ASIENTO COBO SC84
C/ CINTURÓN DE SEGURIDAD
SENSOR PRESENCIA
TAPIZADO TELA GRIS**

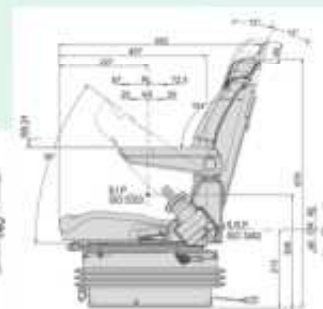
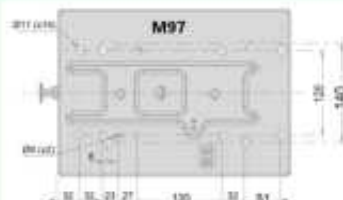

COBO MT

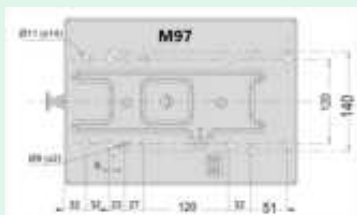

GT62/M97 E8088.444
NEUMATICO
ASIENTO COBO GT62
C/ CINTURÓN DE SEGURIDAD
SENSOR PRESENCIA
TAPIZADO SKY NEGRO

E

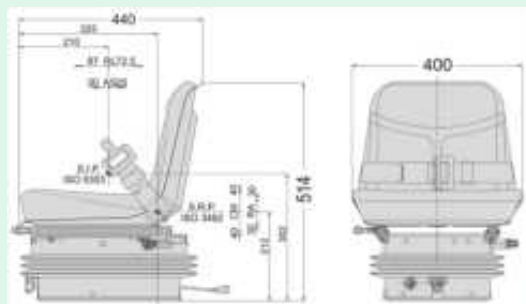

COBO MT

2014.109

MUELLE SUSPENSION
 NEUMATICA M91
 210*28mm

E



2014.127

MUELLE SUSPENSION
 MECANICA M200
 190X37mm

E



2014.135

MUELLE SUSPENSION
 MECANICA M293
 225X26mm

E



COBO MT

2013.002

RESORTE SUSPENSION
 MECANICA M200

E



2013.009

RESORTE SUSPENSION
 NEUMATICA M97

E



2013.010

RESORTE SUSPENSION
 MECANICA M293

E



COBO MT

4074.092

RESPALDO ASIENTO COBO SC74
 MATERIAL:SKY NEGRO

E



4074-700

PARTE BAJA ASIENTO COBO SC74
 MATERIAL: SKY NEGRO

COBO MT

E



COBO MT

A5073.019.02

CINTURON DE SEGURIDAD
 FIJO

E

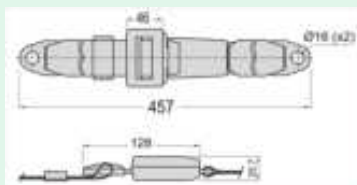

COBO MT

38.0024.0000

SENSOR DE PRESENCIA
 ASIENTOS MT-COBO

CONECTOR SEAL 3 VIAS

38.0025.0000

1031416

SENSOR DE PRESENCIA
 ASIENTOS MT-COBO

CONECTOR SEAL 2 VIAS

1031418



LEYENDA ICONOS

LUZ POBLACIÓN / POSICIÓN DELANTERA			TECNOLOGIA LED
LUZ POBLACIÓN / POSICIÓN TRASERA			LÁMPARA XENÓN
LUZ POBLACIÓN / POSICIÓN TRASERA			LÁMPARA HALÓGENA
INTERMITENTE DELANTERO O TRASERO			LUZ ROTATIVO AZUL
INTERMITENTE DINAMICO			LUZ ROTATIVO AMBAR
LUZ DE CRUZE / CORTAS			LUZ FLASH / DESTELLANTE AZUL
LUZ DE CARRETERA / LARGAS			LUZ FLASH / DESTELLANTE AMBAR
ANTINEBLA TRASERO			LUZ FLASH / DESTELLANTE ROJO
LUZ MARCHA ATRÁS			PROTECCIÓN CONTRA AGUA Y POLVO
FARO TRABAJO / LUZ AMPLIA / FLOOD			PROTECCIÓN CONTRA AGUA Y POLVO
COMBO= FLOOD & SPOT			PROTECCIÓN CONTRA AGUA Y POLVO
FARO LARGO ALCANCE / CARRETA / SPOT			HOMOLOGACIÓN LUCES EMERGENCIA
LUZ GALIBO			HOMOLOGACIÓN COMPATIBILIDAD ELECTRO-MAGNÉTICA
DAY RUNING LIGHTS			HOMOLOGACIÓN LUCES AUXILIARES
CATADRIÓPTICO / REFLEX			LUZ LINEA AZUL CARRETILLAS
LUZ MATRICULA			LUZ LINEA ROJA CARRETILLAS
FIJACIÓN TORNILLO			LUZ PUNTO AZUL CARRETILLAS
CONEXIÓN MECHERO			LUZ PUNTO ROJO CARRETILLAS
SOPORTE IMANTADO			LUZ PERIMETRAL AZUL CARRETILLAS
ESPECIAL CARRETILLAS 48-80V			LUZ PERIMETRAL ROJA CARRETILLAS
ESPECIAL CAN-BUS			LUZ FLECHA AZUL CARRETILLAS
			LUZ FLECHA ROJA CARRETILLAS

DEAFF

57

